

# Panasonic®

## Operating Instructions

### DVD Recorder

Model No. DMR-ES20DEB



This DVD Recorder is for viewing and recording free to view channels only, not pay TV or encrypted channels.

## Sales and Support Information

### Direct Sales at Panasonic UK

- ▶ Order accessory and consumable items for your product with ease and confidence by phoning our Customer Care Centre  
Monday - Thursday 9:00am - 5:30pm, Friday 9:30am - 5:30pm (Excluding public holidays).
- ▶ Or go online through our Internet Accessory ordering application at [www.panasonic.co.uk](http://www.panasonic.co.uk)
- ▶ Most major credit and debit cards accepted.
- ▶ All enquiries, transactions and distribution facilities are provided directly by Panasonic UK Ltd.
- ▶ It couldn't be simpler!
- ▶ Also available through our internet is direct shopping for a wide range of finished products, take a browse on our website for further details.

### Customer Care Centre

- ▶ For customers within the UK: **08705 357357**
- ▶ Visit our website for product information: [www.panasonic.co.uk](http://www.panasonic.co.uk)
- ▶ E-mail: [customer.care@panasonic.co.uk](mailto:customer.care@panasonic.co.uk)

Before connecting, operating or adjusting this product, please read the instructions completely.  
Please keep this manual for future reference.

# Table of Contents

	Page		Page		Page
Important Safety Warnings / Caution	3	Single-frame playback	23	<b>DIRECT NAVIGATOR</b>	
Before You Start	4-5	Quick View	23	Editing	35-36
Included Accessories	4	Splitting a recording into chapters	24	Chapter View	37
Product Introduction	5	Manual Skip	24		
		TIME SLIP	24	<b>PLAYLISTS</b>	
Remote control	6-7	Delayed playback	24	Creating a Playlist	38
Front Panel	8	MP3 playback	25	Select/Edit Playlists	38-39
Rear Panel	8	JPEG playback	26	Edit Chapter	40
Display	9				
21-pin Scart Socket	9	<b>Recording</b>		<b>SETUP</b>	41
Connecting with a 21-pin Scart cable	10	Recording television programmes	27	Tuning	41-44
Setup with Q Link	11	Pause during recording	27	Disc	44
Setup without Q Link	11	One touch recording (OTR)	27	Language codes	44
Connecting with Audio/Video cable	12	Direct TV recording	27	Picture	45
Connecting with S Video cable	12	Playback during recording	27	Sound	45
Connecting to Satellite Receiver	13	Simultaneous recording and playback	27	Display	46
Connecting with RF cable (Aerial cable)	14	Recording modes and approximate		Connection	46
Auto-Setup with RF cable (Aerial cable)	14	recording times in hours	28	Others	47-48
Removing Interference / Changing RF		Selecting an audio channel to be			
output channel	15	recorded in two-channel sound	28	<b>DISC MAGEMENT</b>	
Checking the Settings after Auto-Setup	15	FLEXIBLE REC	28	Disc Name, Disc Protection,	
COMPONENT VIDEO OUT	16	Displaying the available recording time	28	Erase all titles	49
External devices	17			Format Disc	49
		<b>TIMER controlled recordings</b>		Auto-Play Select, Finalize	50
<b>TV Guide</b>	<b>18-19</b>	Options in the TIMER RECORDING menu	28	<b>STATUS</b> displays	<b>51-52</b>
Handling Discs	20	Manual programming	29	Informations	51
Disc formats	20-21	TIMER RECORDING in the TV Guide	30		
		TIMER RECORDING from		<b>DISPLAY</b> menus	<b>53</b>
		analogue channels	30	Before requesting service	<b>54-55</b>
		Programming recordings		Specifications	<b>last page</b>
<b>Playback</b>		with VIDEO Plus+	31	Index	<b>last page</b>
Playback, <b>PAUSE</b> during playback	22	TIMER recording from Sat			
Cancelling playback	22	with VIDEO Plus+	31		
Resuming playback	22	TIMER recordings via external devices	32		
A menu appears on the television screen	22	Recording from an external device,			
Direct playback	22	e.g. a camera	32		
Selecting programmes/ titles for playback	23	<b>FUNCTIONS Selection Menu</b>			
Slow-motion playback,		FUNCTIONS Selection Menu	33		
Fast forward/rewind	23	Symbols in the TIMER RECORDING menu	34		
Skipping chapters, titles or pictures	23	Symbols in the DIRECT NAVIGATOR	34		
		Entering Text	34		

## If you see this symbol

### Information on disposal for users of waste electrical & electronic equipment (private households)

This symbol on the products and/or accompanying documents means that used electrical and electronic products should not be mixed with general household waste. For proper treatment, recovery and recycling, please take these products to designated collection points, where they will be accepted on a free of charge basis. Alternatively, in some countries you may be able to return your products to your local retailer upon the purchase of an equivalent new product. Disposing of this product correctly will help to save valuable resources and prevent any potential negative effects on human health and the environment which could otherwise arise from inappropriate waste handling. Please contact your local authority for further details of your nearest designated collection point. Penalties may be applicable for incorrect disposal of this waste, in accordance with national legislation.



### For business users in the European Union

If you wish to discard electrical and electronic equipment, please contact your dealer or supplier for further information.



### Information on disposal in other countries outside the European Union

This symbol is only valid in the European Union. If you wish to discard this product, please contact your local authorities or dealer and ask for the correct method of disposal.

# Safety Precautions



## Important Safety Warnings

- The moulded three pin mains plug is supplied for your safety and convenience and must NOT be cut off.
- A 5 amp fuse is fitted in the mains plug. If the fuse has to be replaced, it must be of the same rating and approved by ASTA or BSI to BS1362. Check for the ASTA mark  or the BSI mark  on the body of the fuse.

To replace the fuse, open the fuse compartment with a screwdriver as shown and replace the fuse and the cover securely.

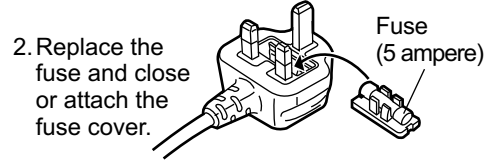
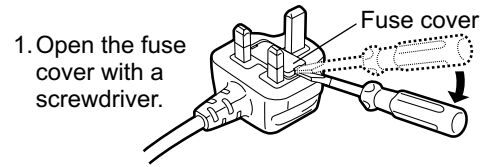

- To prevent electric shock, do not remove cover. No user serviceable parts inside. Refer servicing to qualified service engineer only.
- WARNING:** To reduce the risk of fire, electric shock or product damage, do not expose this apparatus to rain, moisture, dripping or splashing and that no objects filled with liquids, such as vases, shall be placed on the apparatus.
- Do not insert metal object into the slots or openings of the unit.
- This unit is not disconnected from a.c. mains while it remains connected to a live mains outlet, even if it has been turned off.
- The socket outlet shall be installed near the equipment and easily accessible or the mains plug or an appliance coupler shall remain readily operable.
- This unit is intended for use in moderate climates.

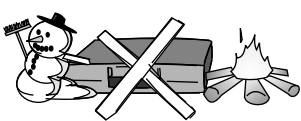
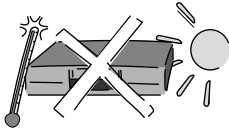
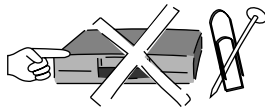

## Caution

- Avoid exposing the unit to direct sunlight or other heat sources.
- Avoid sudden change in temperature or humidity, dew or condensation may form, causing malfunction.
- Dispose of batteries in accordance with the instructions given in this book.
- Place the unit on a flat, stable surface. Do not place heavy object on top of the unit.
- Your attention is drawn to the fact that recording of pre-recorded tapes or discs or other published or broadcast materials may infringe copyright laws.
- This unit is designed for indoor use only.
- Do not use in area with strong magnetic fields, e.g. near transmitting antenna.
- This product may receive radio interference caused by mobile telephones during use. If such interference is apparent, please increase separation between the product and the mobile telephone.
- Do not install or place this unit in a bookcase, built-in cabinet or in another confined space. Ensure the unit is well ventilated. To prevent risk of electric shock or fire hazard due to overheating, ensure that curtains and any other materials do not obstruct the ventilation vents.
- Do not obstruct the unit's ventilation openings with newspapers, tablecloths, curtains, and similar items.
- Do not place sources of naked flames, such as lighted candles, on the unit.
- Dispose of batteries in an environmentally friendly manner.

- This product utilizes a laser. Use of controls or adjustments or performance of procedures other than those specified herein may result in hazardous radiation exposure. Do not open covers and do not repair yourself. Refer servicing to qualified personnel.



Back of product, see page 8

Inside of product

<b>DANGER</b>	- VISIBLE AND INVISIBLE LASER RADIATION WHEN OPEN. AVOID DIRECT EXPOSURE TO BEAM. (FDA 21 CFR)
<b>CAUTION</b>	- VISIBLE AND INVISIBLE LASER RADIATION WHEN OPEN. AVOID EXPOSURE TO BEAM. (IEC60825-1)
<b>ATTENTION</b>	- RAYONNEMENT LASER VISIBLE ET INVISIBLE EN CAS D'OUVERTURE. EXPOSITION DANGEREUSE AU FASCEAU.
<b>ADVARSEL</b>	- SYNLIG OG USYNLIG LASERSTRÅLING VED ÅBNING. UNDGÅ UDSÆTTELSE FOR STRÅLING.
<b>VARO!</b>	- AVATTAESSA OLET ALTTIINA NÄKYVÄÄ JA NÄKYMÄTÖN LASERSÄTEILYLLE. ÄLÄ KATSO SÄTEESEEN.
<b>VARNING</b>	- SYNLIG OCH OSYNLIG LASERSTRÅLNING NÄR DENNA DEL ÄR ÖPPNAD. BETRÄKTA EJ STRÅLEN.
<b>ADVARSEL</b>	- SYNLIG OG USYNLIG LASERSTRÅLING NÄR DEKSEL ÅPNES. UNNGÅ EKSPONERING FOR STRÅLEN.
<b>VORSICHT</b>	- SICHTBARE UND UNSICHTBARE LASERSTRALHUNG, WENN ABDECKUNG GEÖFFNET. NICHT DEM STRALH AUSSETZEN.
<b>注意</b>	- 打开时有可见及不可见激光辐射。避免激光束照射。
<b>注意</b>	- ここを開くと可視及び不可視のレーザー光が出ます。ビームを直接見たり、触れたりしないでください。 ROLS0233



## Care and Maintenance

- The cabinet can be wiped clean with a damp cloth, disconnect from mains before cleaning. Do not use detergent or solution containing benzol or petroleum.

# Before You Start

## Dear customer

Thank you for your trust and your decision to purchase this top-quality device. Panasonic is one of the leading manufacturers of entertainment electronics devices. We are sure that you will be completely satisfied with this device. With the new Quick Start feature, the unit is ready for use within approx. 1 second. Thus, if a DVD-RAM was previously inserted, recording can begin immediately after the unit is switched on from Standby mode.

**Matsushita Electric Industrial Co., Ltd.**

<http://www.panasonic.co.jp/global/>

Check that you have the accessories and items shown

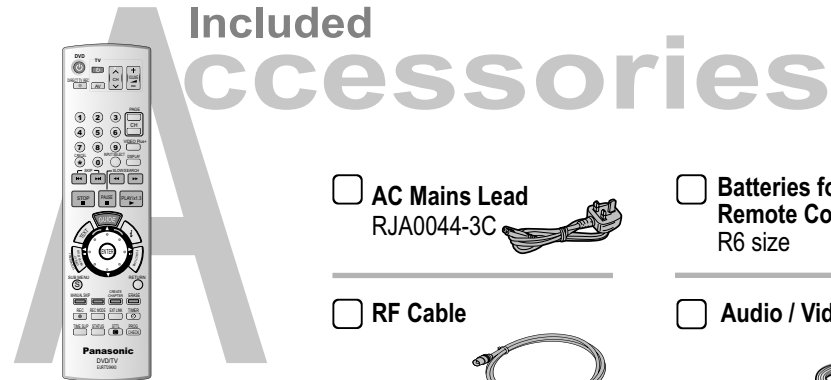

<input type="checkbox"/> Remote control EUR7729KK0	<input type="checkbox"/> AC Mains Lead RJA0044-3C	<input type="checkbox"/> Batteries for the Remote Control R6 size
<input type="checkbox"/> Guarantee Card	<input type="checkbox"/> RF Cable K1TWACC00001	<input type="checkbox"/> Audio / Video Cable K2KA6CA00001
<input type="checkbox"/> Quick Start Guide	<input type="checkbox"/> Operating Instructions	

## Preparation

1. **Read the operating instructions**, the safety precautions and the information on setting up the unit on page 3 thoroughly before you connect, operate or adjust any settings on the unit.

2. **Insert the batteries into the remote control.**

3. **Connect the device to your television.**

Connecting with 21-pin Scart cable

Connecting with RF cable (Aerial cable)

Connecting with Audio/Video cable

Connecting with S VIDEO cable

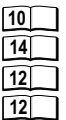

4. **The automatic settings start after the unit is switched on.**

The station settings of all receivable television stations are automatically transferred to the DVD Recorder. The Auto-Setup begins with download of the digital data afterwards starts the download of analogue data.

With Q Link function and 21-pin Scart socket:

First Auto-Setup begins with download of the digital data. Then during [Download from TV], the station settings of all receivable analogue television stations are automatically transferred from your television set to the DVD Recorder.

**Connecting with 21-pin Scart cable:**

Setup with Q Link

Setup without Q Link (Automatic Tuning)



**Connecting with RF cable (Aerial cable):**

Auto-Setup with RF cable (Aerial cable) (Automatic Tuning)



**Connecting with Audio/Video cable / S VIDEO cable:**

Setup without Q Link (Automatic Tuning)



5. **The basic settings of the unit are complete.**

You can change the basic settings in the SETUP menu.



## Before You Start

Fit the batteries into the remote control

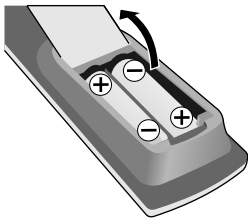

### Inserting Batteries

The batteries last for about a year, depending on how often you use the remote control unit.

- Do not mix old with new batteries, or batteries of different types.
- Only use batteries without any harmful substances (lead, cadmium, mercury).
- Do not use rechargeable type batteries.
- Remove the batteries if the remote control unit will remain unused for longer periods of time.
- Do not heat or short-circuit the batteries.  
Immediately remove used-up batteries and replace with batteries of type AA, UM3 or R6.
- Be sure to put in the batteries the right way round + and -.

Dispose of **batteries**, packaging material and the unit according to statutory regulations. They must not be thrown into the household refuse.



### Product Introduction

This unit is a DVD recorder with an integrated DVB tuner. This means that you can receive and record both analogue and terrestrial digital channels without having to connect an additional DVB receiving unit (set-top box). Your unit has many additional useful features especially for the digital channels.

#### TV Guide

Electronic programme guide with current information on the programme and a 7-day preview. Broadcasts can also be sorted by categories. Recording is easy by selecting the desired station.

18

#### Edit Profiles

Create profiles (station lists) in which your preferred stations can be sorted and saved. Find your favourite stations quickly at the accustomed programme locations.

42

DVB only

#### Banner

When switching stations, Banners appear that immediately display the current and next programme.

52

DVB only

#### Subtitles

You can show or hide subtitles (if available for the programme). Subtitles can also be recorded.

52

DVB only

#### Multi Audio

With Multi Audio, you can choose from different audio channels for a programme. For example, if a movie is broadcast with Multi Audio, you can listen to the movie either with the original sound or its English translation.

52

DVB only

#### MHEG

The unit can receive MHEG service.

52

#### Q Link

With the Q Link feature, the television accepts analogue stations directly. A station scan does not need to be performed for the analogue stations.

11

# Remote control



## Standby/on switch

Press to switch the unit from on to standby mode or vice versa. In standby mode, the unit is still consuming a small amount of power. Switching this unit into standby mode does not disconnect it from the mains.

DIRECT TV REC



Direct TV record to DVD

27

CANCEL



Cancel button



**SKIP:** Skip chapters, titles or pictures.

23



Stop recording, replay or forward/reverse action.

22



Pauses a recording or playback.

22



Launch the TV Guide.

18



**DVB only** Launch the MHEG service. Exit in the MHEG service.

52



**DIRECT NAVIGATOR TITLE VIEW TOP MENU:** Main menu of DVD-Video.

35



Direction buttons in the menu navigation. Selection of groups **▲▼▶◀** or titles. **⏸** Freeze frame or time loop playback.

SUB MENU



Launch sub menus.

MANUAL SKIP



**Manual Skip:** Jump forwards 30 seconds. **Red Button:** Functions in MHEG Service, Manual Tuning, TV Guide.

24



**Green Button:** Functions in MHEG Service, Edit Profile, TV Guide.



Record

27

REC MODE



Record mode button (XP, SP, LP, EP)

28

TIME SLIP



**TIME SLIP:** Select the timeframe to be skipped.

24

STATUS



Detail information appears on the screen.

51

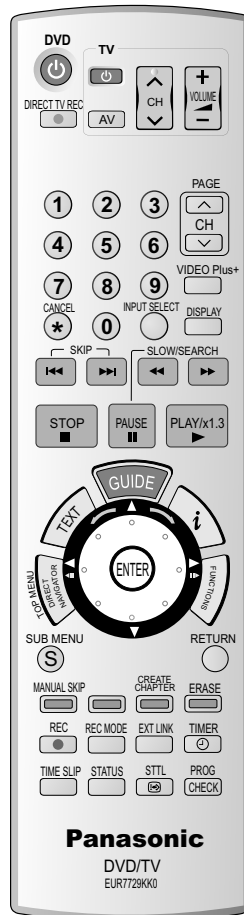

TV



Turn the television set on and off.



Select the AV input on the television set.



**CH:** Select the channel on the television set.

**VOLUME:** Volume control of the television set.

## ① ② ③ Numeric buttons - direct input, example

④ ⑤ ⑥ **VCD** 5: ④ + ⑤ 15: ① + ⑤

⑦ ⑧ ⑨ **MP3/JPEG** 5: ⑦ + ⑧ + ⑨ 15: ⑦ + ⑧ + ⑨

⑩ Channel e.g. 800: ⑩ + ⑩ + ⑩

INPUT SELECT



Switch button of the AV input between AV1, AV2, AV3 (front) and AV4.



Select or save a setting

PAGE



**PAGE:** Page in the electronic TV Guide.

**CH:** Channel select button.

VIDEO Plus+



VIDEO Plus+ menu

31

DISPLAY



Launch the disc menu.

53

SLOW/SEARCH



**SLOW/SEARCH:** Search or slow motion playback

23

PLAY/x1.3



Starts playback.

**PLAY/x1.3 RAM**

You can increase the playback speed. Hold **PLAY** during playback.

22

23



Display the Banner.

52



FUNCTIONS selection menu.

33+35

RETURN



Exit a menu.

CREATE CHAPTER



**Create Chapter:** Split the recording into chapters. **Yellow Button:** Functions in MHEG Service, Edit Profile, TV Guide.

24

ERASE



**Erase:** Erase a title during playback.

**Blue Button:** Functions in MHEG Service, Edit Profile, TV Guide, Banner.

35

EXT LINK



Record with external recording control.

32

TIMER



Switch timer on and off.

29

STTL



**DVB only** Displays or hides subtitles.

**Audio L/R function:** Press and hold **STTL** for more than 5 seconds.

52

PROG CHECK



TIMER RECORDING menu

29

# Remote control

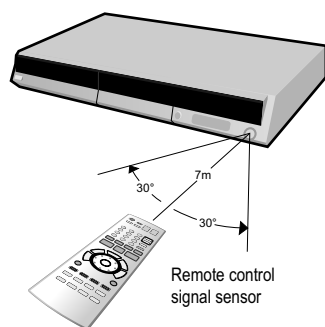

Point the remote control at the unit's sensor. Avoid obstacles in the path of the transmission. The maximum range of the remote control is 7 m directly in front of the unit. Keep the transmission window and the unit sensor clean. The procedure can be impaired by direct sunlight or doors of glass cabinets.

## Child lock

You can lock the buttons of the unit and the remote control.

- Press and hold **RETURN** and **ENTER** until **X HOLD** appears in the display. The unit is now locked.
- In order to unlock the child lock, repeat the procedure until **X HOLD** disappears.

## Operating a television set

Change the remote control code to operate your television set.

- Press and hold the **TV** on and off switch button.
- Enter the two-digit code for your television set. The input must be repeated after batteries are changed.

Trademark	Code	Trademark	Code	Trademark	Code	Trademark	Code
Panasonic	01-04,45	GOLDSTAR/LG	31	MIVAR	24	SALORA	26
AIWA	35	GOODMANS	05,06,31	NEC	36	SAMSUNG	31,32,43
AKAI	27,30	GRUNDIG	09	NOKIA	25-27	SANSUI	05,31,33
BLAUPUNKT	09	HITACHI	22,23,31,40-42	NORDMENDE	10	SANYO	21
BRANDT	10,15	INNO HIT	34	ORION	37	SBR	06
BUSH	05,06	IRRADIO	30	PHILIPS	05,06	SCHNEIDER	05,06,29-31
CURTIS	31	ITT	25	PHONOLA	31,33	SELECO	06,25
DESMET	05,31,33	JVC	17,39	PIONEER	38	SHARP	18
DUAL	05,06	LOEWE	07	PYE	05,06	SIEMENS	09
ELEMIS	31	METZ	28,31	RADIOLA	05,06	SINUDYNE	05,06,33
FERGUSON	10	MITSUBISHI	06,19,20	SABA	10	SONY	08
						TELEFUNKEN	10-14
						THOMSON	10,15,44

Some television models of the brands listed above, (e.g. older Panasonic units), cannot be operated using the remote control.

## Switching to AV input on your Panasonic television set

- Press **AV**. Each press of the button switches between TV reception and AV input.

If you use another Panasonic device at the same location, change the mode of the remote control so that you can operate the units independently of each other.



## Setting the remote control

Setting the remote control mode for unit.

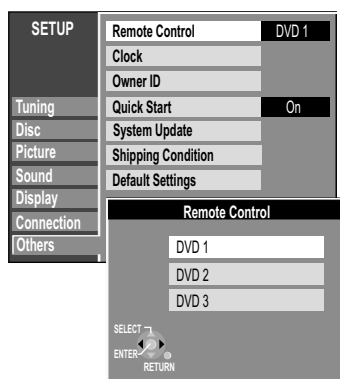

- Press **FUNCTIONS** in stop mode.
- Use **▲▼** to select [To Others] and confirm with **ENTER**.
- Use **▲▼** to select **SETUP** and confirm with **ENTER**.
- Use **▲▼** to select [Others], **▶** to select [Remote Control] and confirm with **ENTER**.
- Use **▲▼** to select the desired mode [DVD 1, 2 or 3] and confirm with **ENTER**.

Accept the desired mode on the remote control.

- Press and hold the **ENTER** button for approx. 2 seconds and, at the same time, enter the number that corresponds to the selected mode (1, 2 or 3).
- Press **RETURN** to exit the menu.

If the mode of the remote control does not correspond with that of the unit, [REMOTE DVD 1 / 2 / 3] will appear on the unit display.



- Press and hold the **ENTER** button for approx. 2 seconds and, at the same time, enter the number that corresponds to the selected mode (1, 2 or 3).

If you want to operate two units independently of each other with the same remote control, then change the mode of the remote control.

The input must be repeated after batteries are changed.

# Front Panel

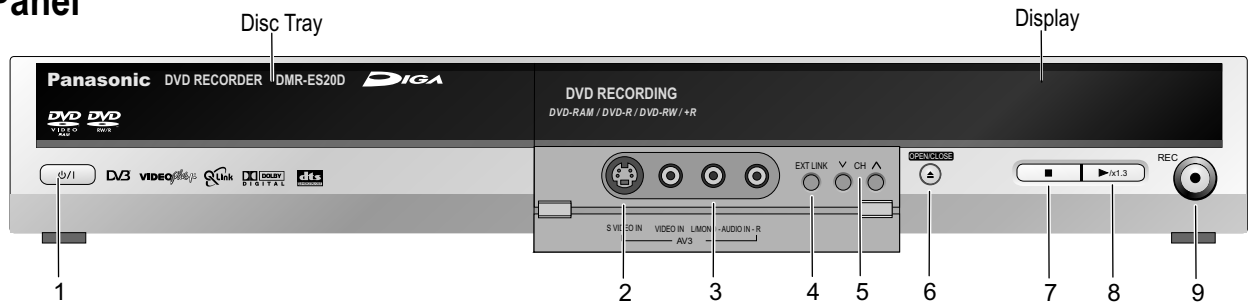

1		<b>Standby/on switch</b> Press to switch the unit from on to standby mode or vice versa. In standby mode, the unit is still consuming a small amount of power.
<b>Front Connections</b>		
2		S VIDEO Input (AV3)
3		AV3 Input Terminal
<b>Front Access</b>		
4	<b>EXT LINK</b>	Recording with external recording control
<b>DVD</b>		
5		Channel selector button
6		Open and close the disc tray
7		Stop
8		Playback / x1.3
9		Record

# Rear Panel

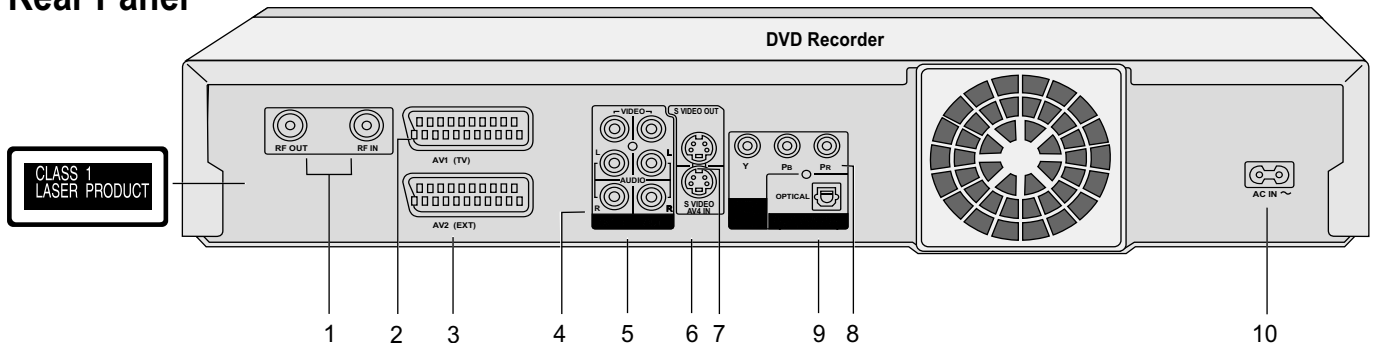

<b>Connections</b>		
1	RF OUT	= Aerial output      RF IN = Aerial input
2	AV1 (TV)	21-pin Scart socket = TV connection
3	AV2 (EXT)	21-pin Scart socket = connection to an external unit
4	AV4 IN	= Audio input right/left channel Video input
5	OUT	= Audio output right/left channel Video output
6	S VIDEO AV4 IN	= S VIDEO input socket
7	S VIDEO OUT	= S VIDEO output socket
8	COMPONENT VIDEO OUT (PROGRESSIVE/INTERLACE) Y = Luminance signal (luminance) P <sub>B</sub> = Chrominance signal (colour difference)    P <sub>R</sub> = Chrominance signal (colour difference)	
9	OPTICAL DIGITAL AUDIO OUT (PCM BITSTREAM) = Digital audio output	
10	AC IN~ = Power supply	



# Display

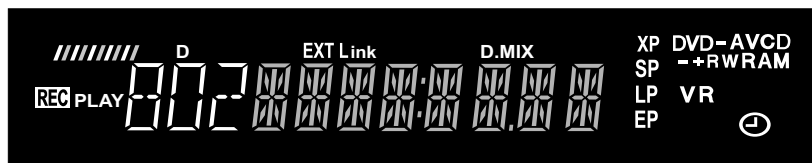

Information on the display							
	TIMER-controlled recording. <b>Blinking:</b> There are less than 10 minutes until the start of a programmed TIMER recording. The device is not set to TIMER standby mode.						
EXT Link	External-Link display <b>On:</b> A TIMER-controlled recording is being performed by an external device.						
	Current time, Disc recording and playback counter, various messages.						
	Reading Disc.						
REC	Recording						
PLAY	Playback						
PLT	<table border="0"> <tr> <td><b>PL</b> Number of Playlist</td> <td><b>T</b> Title number</td> </tr> <tr> <td><b>T</b> Track number</td> <td><b>C</b> Chapter number</td> </tr> <tr> <td><b>G</b> Group number</td> <td><b>100</b> Channel number</td> </tr> </table>	<b>PL</b> Number of Playlist	<b>T</b> Title number	<b>T</b> Track number	<b>C</b> Chapter number	<b>G</b> Group number	<b>100</b> Channel number
<b>PL</b> Number of Playlist	<b>T</b> Title number						
<b>T</b> Track number	<b>C</b> Chapter number						
<b>G</b> Group number	<b>100</b> Channel number						
REC PLAY	Simultaneous Recording/Playback						
D.MIX	Down-Mix						
XP, SP LP, EP	Record mode <b>All on:</b> FR mode (for flexible recordings or TIMER-controlled recordings).						
D	Digital channel						
DVD-RAM VCD +RW VR	Disc type e.g.: DVD-RAM, DVD-R, ,DVD-RW(VR), DVD-Video, Video-CD.						

## 21-pin Scart Socket

The 21-pin Scart socket transmits both input and output signals for picture and sound. TVs equipped with the same type of socket can be connected here. This type of socket is also called Peritel, Euro Connector and Euro AV.

### 21-pin Scart Socket

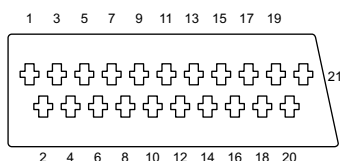

#### AV1 Scart Socket (NORMAL)

- 1 Audio output CH2 (R)
- 2 Audio input CH2 (R)
- 3 Audio output CH1 (L)
- 4 Audio ground
- 5 Blue ground
- 6 Audio input CH1 (L)
- 7 Blue
- 8 Switching voltage
- 9 Green ground
- 10 Reserved
- 11 Green
- 12 No connection
- 13 Red ground
- 14 Blanking ground
- 15 Red
- 16 Blanking
- 17 Video output ground
- 18 Video input ground
- 19 Video output
- 20 Video input
- 21 Ground

#### AV2 Scart Socket

- 1 Audio output CH2 (R)
- 2 Audio input CH2 (R)
- 3 Audio output CH1 (L)
- 4 Audio ground
- 5 Blue ground
- 6 Audio input CH1 (L)
- 7 Blue
- 8 Switching voltage
- 9 Green ground
- 10 Control signal
- 11 Green
- 12 Reserved
- 13 Red ground
- 14 Blanking ground
- 15 Red
- 16 Blanking
- 17 Video output ground
- 18 Video input ground
- 19 Video output
- 20 Video input
- 21 Ground

## Connecting with a 21-pin Scart cable

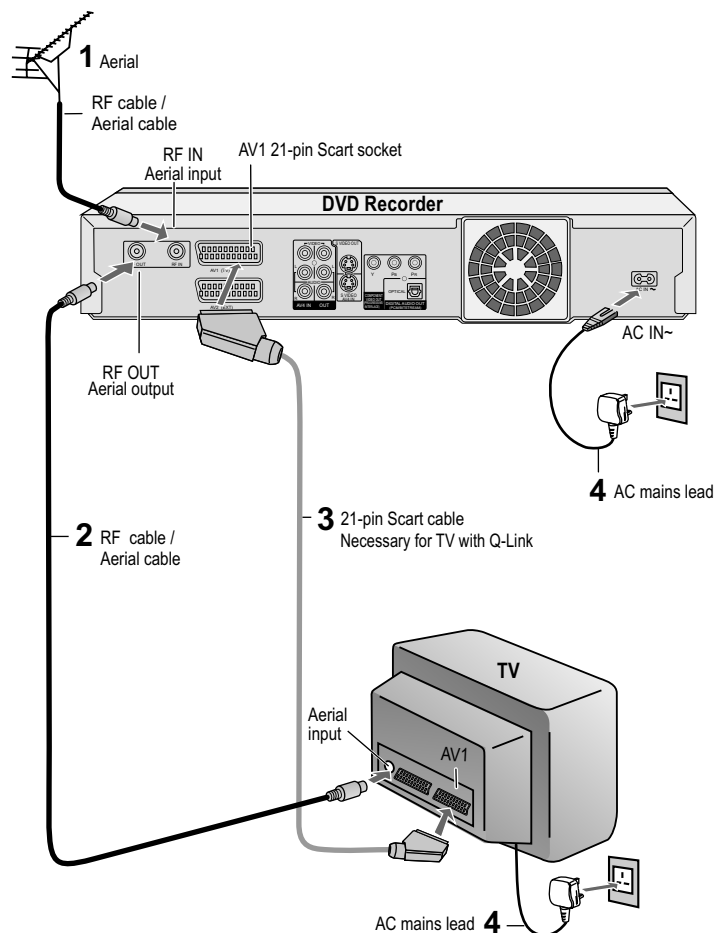

### Follow the steps below.

Disconnect AC mains from all units.

- 1 Connect the aerial to the RF IN (Aerial input) of the DVD Recorder.
- 2 Connect the RF OUT (Aerial output) of the DVD Recorder to the Aerial input of the television set.
- 3 Connect the AV1 socket (21-pin Scart socket) of the DVD Recorder to the Scart input of the television set.
- 4 Connect the DVD Recorder and the television set to the AC mains socket.

If your television supports Q Link follow the steps for Auto-Setup with Q Link on page 11. If your television doesn't support Q Link follow the steps for Auto-Setup without Q Link on page 11.

*If your television supports Q Link or RGB, connect it to the DVD Recorder with a fully wired 21-pin Scart cable.*

SETUP - Connection - [AV1 Output]

46

*Note: For all connections additional cables and equipment shown are not supplied.*

## Setup with Q Link

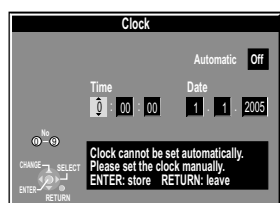
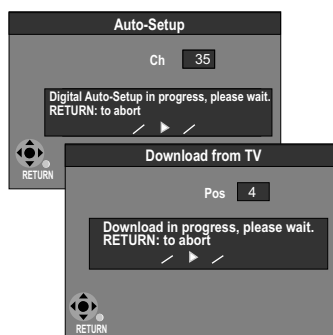

### Download from TV using QLink (Registered trademark of Panasonic)

You can download the tuning positions for analogue channels from the TV set. Time and date will be set automatically by Auto Clock Setting function.

Note that you must first perform a station search if you use the TV for the first time.

If you have a Panasonic television, [Download from TV] will be displayed automatically at the beginning of the station transfer.

- Switch your television on and select the AV channel.
- Switch the device on using the **Standby/on switch**.

*The unit starts the station transfer. A station search for the digital channel starts first. The number of channels found is displayed on the screen after the station search. Then the analogue station positions are automatically transferred from the television. The station transfer is complete when the Owner ID screen appears.*

### Owner ID

You can complete the Owner ID now or skip this step and do it later. To do it later, press the **RETURN** button. Your DVD Recorder is now ready to use.

- To set the Owner ID now, use **▶** and press the **Numeric** buttons or **▲▼▶** to enter a four-digit PIN number. Press **◀**, to correct the digit.
- Make sure that you will remember the PIN number (make a note of it).
- Press the **ENTER** button twice to confirm.
- Enter the [Name], [House No] and [Postcode] in the same way, using **▲▼◀▶**.
- Press the **ENTER** button to confirm each entry.
- Press the **RETURN** button to leave the Owner ID screen.
- You will now see the TV picture. Your DVD Recorder is now ready to use.

### If the clock setting menu appears

(Auto clock set was not possible due to a weak signal)

- Press **▲▼◀▶** to set the correct time and date and press **ENTER** to finish this setting.

*Note: A wrong date or time will influence the programmed recording of TV programmes (don't forget to change summer time and winter time).*

*If Auto-Setup has previously been completed the DVD Recorder will not start Auto-Setup automatically. In this case you can re-start Auto-Setup again.*

*If you want to cancel Auto-Setup before it has finished, press the **RETURN** button. You can restart Auto-Setup again.*

43

## Setup without Q Link (Automatic Tuning)

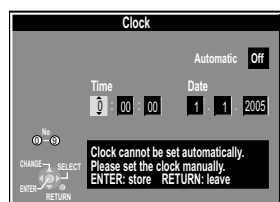
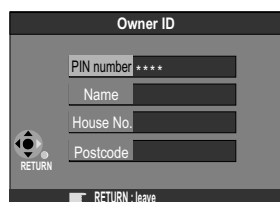
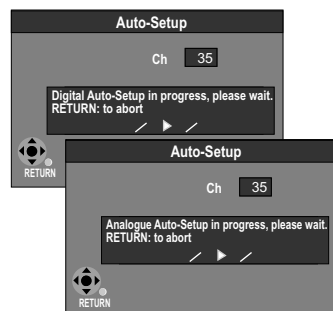

### Auto-Setup

The automatic setup saves all available TV stations. If the station also broadcasts date and time, then the clock is also set automatically.

- Switch on your television and select the AV channel.
- With the **Standby/on switch** turn on the DVD Recorder. Automatic tuning for all available TV stations begins. The search is first performed for the digital and then the analogue stations. The number of channels found is displayed on the screen after the station search. Approximate duration is 5 minutes. After Automatic tuning has finished, the Owner ID screen will appear.

### Owner ID

You can complete the Owner ID now or skip this step and do it later. To do it later, press the **RETURN** button. Your DVD Recorder is now ready to use.

- To set the Owner ID now, use **▶** and press the **Numeric** buttons or **▲▼▶** to enter a four-digit PIN number. Press **◀**, to correct the digit.
- Make sure that you will remember the PIN number (make a note of it).
- Press the **ENTER** button twice to confirm.
- Enter the [Name], [House No] and [Postcode] in the same way, using **▲▼◀▶**.
- Press the **ENTER** button to confirm each entry.
- Press the **RETURN** button to leave the Owner ID screen.
- You will now see the TV picture. Your DVD Recorder is now ready to use.

### If the clock setting menu appears

(Auto clock set was not possible due to a weak signal)

- Press **▲▼◀▶** to set the correct time and date and press **ENTER** to finish this setting.

*Note: A wrong date or time will influence the programmed recording of TV programmes (don't forget to change summer time and winter time).*

*If Auto-Setup has previously been completed the DVD Recorder will not start Auto-Setup automatically. In this case you can re-start Auto-Setup again. If you want to cancel Auto-Setup before it has finished, press the **RETURN** button.*

*You can restart Auto-Setup again.*

43

## Connecting with Audio/Video cable

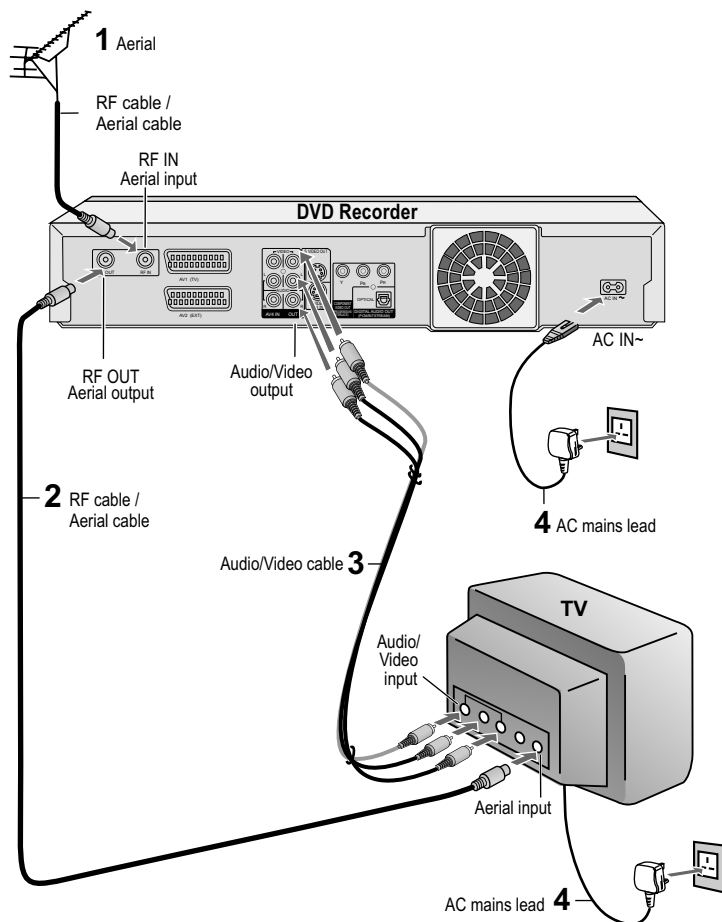

Follow the steps below.

Disconnect the AC mains from all units.

- 1 Connect the aerial to the RF IN (Aerial input) of the DVD Recorder.
- 2 Connect the RF OUT (Aerial output) of the DVD Recorder to the Aerial input of the television set.
- 3 Connect the AV4 OUT (AUDIO L/R, VIDEO) of the DVD Recorder to the input of the television set.
- 4 Connect the DVD Recorder and the television set to the AC mains socket.

Follow the steps for Auto-Setup without Q Link on page 11.

## Connecting with S VIDEO cable

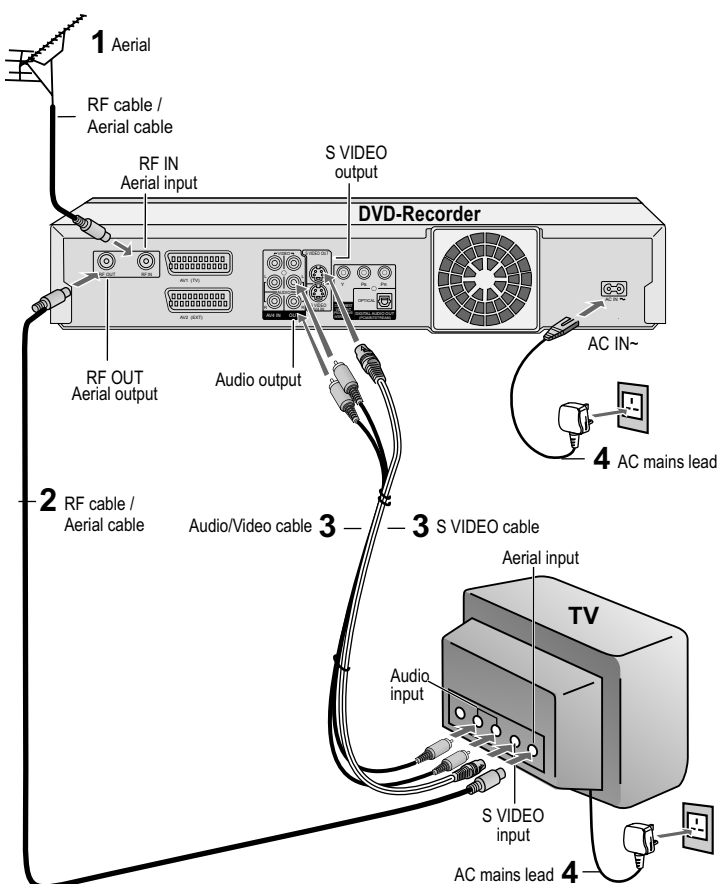

Follow the steps below.

Disconnect the AC mains from all units.

- 1 Connect the aerial to the RF IN (Aerial input) of the DVD Recorder.
- 2 Connect the RF OUT (Aerial output) of the DVD Recorder to the Aerial input of the television set.
- 3 Connect the AV4 OUT (AUDIO L/R) of the DVD Recorder to the input of the television set. Connect the S VIDEO OUT of the DVD Recorder to the input of the television set.
- 4 Connect the DVD Recorder and the television set to the AC mains socket.

Follow the steps for Auto-Setup without Q Link on page 11.

# Connecting to a Satellite Receiver

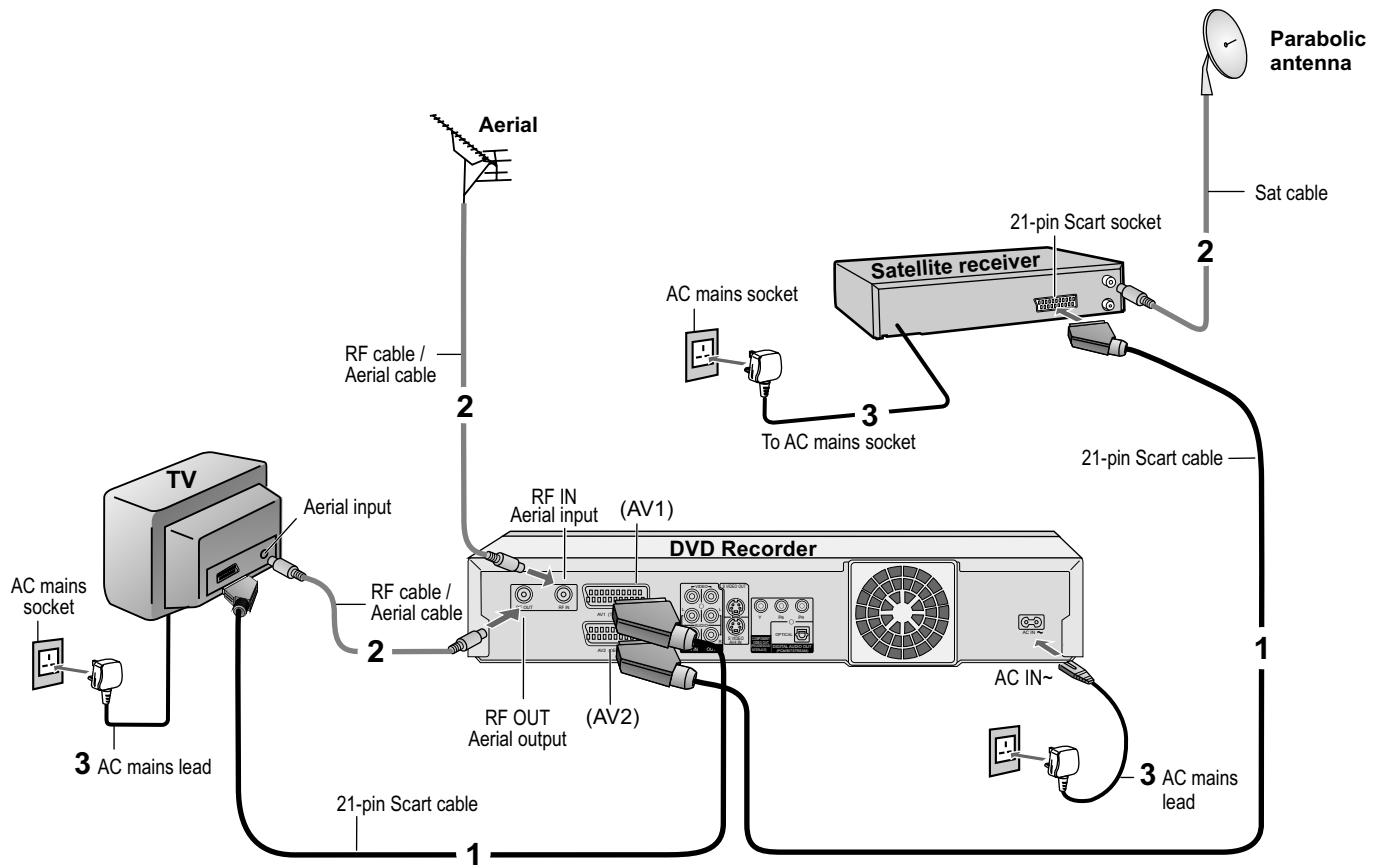

## Follow the steps below.

Disconnect the AC mains from all units.

- 1 Connect a 21-pin Scart cable (fully wired) to the AV2 21-pin Scart socket of the DVD Recorder and to the 21-pin Scart socket of the satellite receiver. Connect a 21-pin Scart cable (fully wired) to the AV1 21-pin Scart socket of the DVD Recorder and to the 21-pin Scart socket of the TV set.
- 2 Connect aerial to the RF IN (Aerial input) of the DVD Recorder. Connect the parabolic antenna to the Aerial in connector of the satellite receiver. Connect the DVD Recorder's RF OUT (Aerial output) to the TV set's Aerial in connector.
- 3 Connect the satellite receiver, DVD Recorder and TV set to the AC mains supply.

Switch on the TV set and DVD Recorder.

Set the settings for AV2 according to the connected satellite receiver.



Switch on the satellite receiver. Then follow page 11 for Auto-Setup with 21-pin Scart cable.

## Connecting with RF cable (Aerial cable)

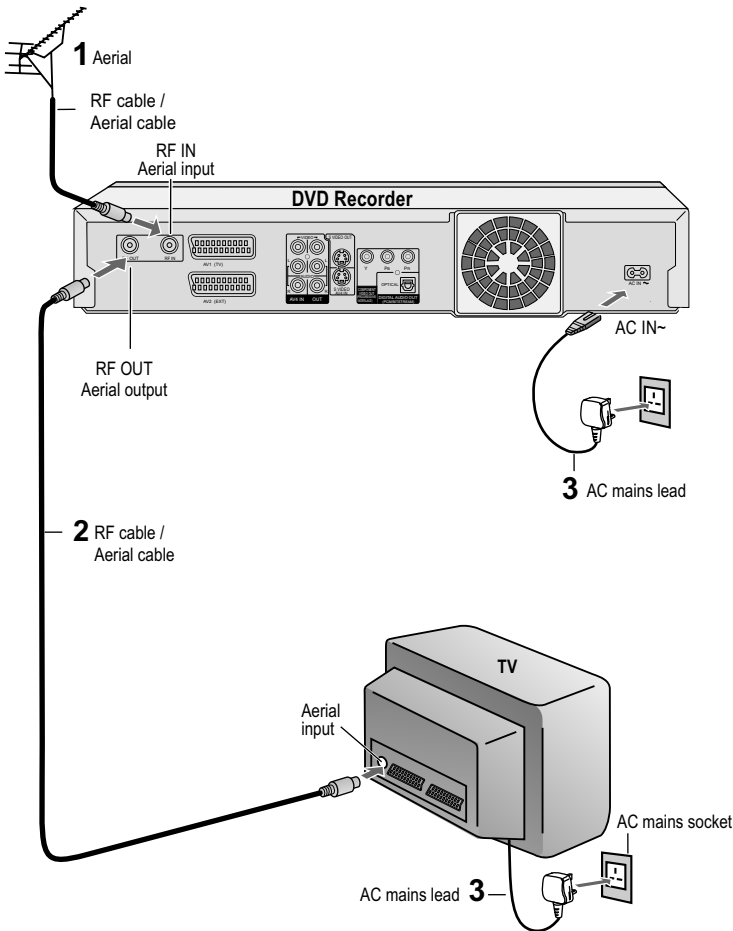

Follow the steps below.

Disconnect the power of all units.

- 1 Connect aerial to the RF IN (Aerial input) connector of the DVD Recorder.
- 2 Connect the DVD Recorder's RF OUT (Aerial output) to the TV set's Aerial in connector.
- 3 Connect DVD Recorder and TV set to the AC mains socket.

Follow the steps for Auto-Setup on page 14.

### Auto-Setup with RF cable (Aerial cable) (Automatic tuning)

DVD Display

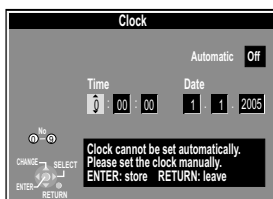
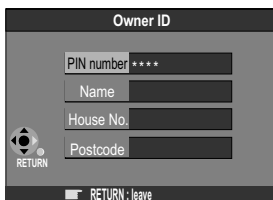
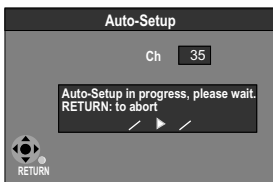

- Turn on your television set.
- With the **Standby/on switch** turn on the DVD Recorder. Automatic tuning for all available TV stations begins. Approximate duration is 5 minutes.

- While Auto-Setup is running the first digit of the DVD Recorder display will flash. After a while it will stop flashing and the RF output channel number will be displayed.

- Select an unused channel pre-set on your TV and tune it to the RF output channel number shown on the DVD Recorder display (or until you can clearly see the Auto-Setup screen). Store the new RF output channel (refer to the instructions for your TV).

- After Automatic tuning has finished, the Owner ID screen will appear.

*In some cases, the RF output channel may interfere with the TV stations transmitted in your area. This may prevent you from seeing the On-Screen Display clearly.*

*Please see page 15 for removing the interference before restarting Auto-Setup.*

43

### Owner ID

You can complete the Owner ID now or skip this step and do it later. To do it later, press the **RETURN** button. Your DVD Recorder is now ready to use.

- To set the Owner ID now, use **▶** and press the **Numeric** buttons or **▲▼▶** to enter a four-digit PIN number. Press **◀**, to correct the digit.
- Make sure that you will remember the PIN number (make a note of it).
- Press the **ENTER** button twice to confirm.
- Enter the [Name], [House No] and [Postcode] in the same way, using **▲▼◀▶**.
- Press the **ENTER** button to confirm each entry.
- Press the **RETURN** button to leave the Owner ID screen.
- You will now see the TV picture. Your DVD Recorder is now ready to use.

### If the clock setting menu appears

(Auto clock set was not possible due to a weak signal)

- Press **▲▼◀▶** to set the correct time and date and press **ENTER** to finish this setting.

*Note: A wrong date or time will influence the programmed recording of TV programmes (don't forget to change summer time and winter time).*

## Removing Interference / Changing RF output channel



TV screen  
The picture with interference



On-Screen Display  
Test pattern indication

DVD display



Indication when the RF output channel is 21 (example)



Indication after changing the RF output channel to 31 (example)



Test pattern indication



The clear picture

In some cases, interference (lines or patterning) or a very poor picture may appear on the TV when the DVD Recorder is connected. If this happens, follow the steps below to change the RF output channel to remove the interference.



- Press the **FUNCTIONS** button for more than 5 seconds. The RF output channel number is displayed on the DVD display.



- Press the **Numeric** buttons or use the Channel (**CH**) button to select a channel number, which differs at least by 2 or 3 from the present channel number. (For example, if the original channel number was 28, enter 31.)

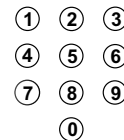

- Retune your TV until you receive the Test pattern. It may be necessary to repeat steps above until you can see the Test pattern clearly. If using a Scart cable please see the note below.



- Press **ENTER** to finish this setting.

Set the RF output channel of the DVD Recorder to [- -] (RF OFF) if the DVD Recorder is connected to the TV via the 21-pin Scart cable.

- Press **FUNCTIONS** for about 5 seconds. The preset channel will be displayed on the DVD display.
- Press channel select buttons **CH** or **0** to invoke [- -].
- Confirm with **ENTER**.

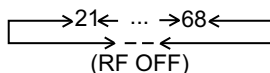

## Checking the Settings after Auto-Setup



- Press **FUNCTIONS** to display the FUNCTIONS Menu.
- Press **▼▲** to select [To Others] and then press **ENTER**.
- Press **▼▲** to select **SETUP** and then press **ENTER**.

- Press **▶** to select [Manual] and then press **ENTER** to display the list of tuned TV stations and confirm that all available TV stations have been set correctly.

If station name is [\*\*\*\*]:

The asterisks indicate that a station was found during Auto-Setup but has not been named (due to weak signal).

The stations in the list with asterisk will need to be named manually.

44

If station name is [- - -]:

The dashes represent unused channel positions.

You can set stations manually if you want to.

44

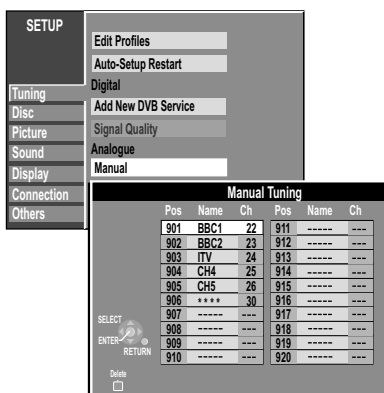

TV Reception Channels



- Press **RETURN** to exit the On Screen Display.

When the station names have not been set correctly, see page 44 for details.

When no station has been found, confirm all connections of the DVD Recorder again and restart the Auto-Setup. See page 43 for details.

- Check and sort your digital channel in the Setup menu under [Edit Profiles]. See page 42 for details.

# COMPONENT VIDEO OUT

## COMPONENT VIDEO OUT socket

These sockets can be used for interlace or progressive output and deliver a clearer picture than the S VIDEO OUT socket. Connections via these sockets output colour difference signals (P<sub>B</sub>/P<sub>R</sub>) and brightness signal (Y) separately. The properties of the COMPONENT VIDEO input socket are dependent on the television set or screen.

Always connect sockets of the same colour.

Connect the Audio cable to the corresponding audio input sockets of the television.

## Connecting a television with COMPONENT VIDEO input sockets

If your television with LCD or plasma screen supports the progressive procedure, connect it to the COMPONENT VIDEO OUT sockets.

If you want to enjoy progressive-quality video, set Progressive to [On].

- Press **FUNCTIONS** in stop mode.
- Use **▼▲** to select [To Others] and confirm with **ENTER**.
- Use **▼▲** to select SETUP and confirm with **ENTER**.
- Use **▼▲** to select [Connection], **▶**, **▼▲** to select [Progressive] and confirm with **ENTER**.
- Use **▼▲** to select the [On] option and confirm with **ENTER**.

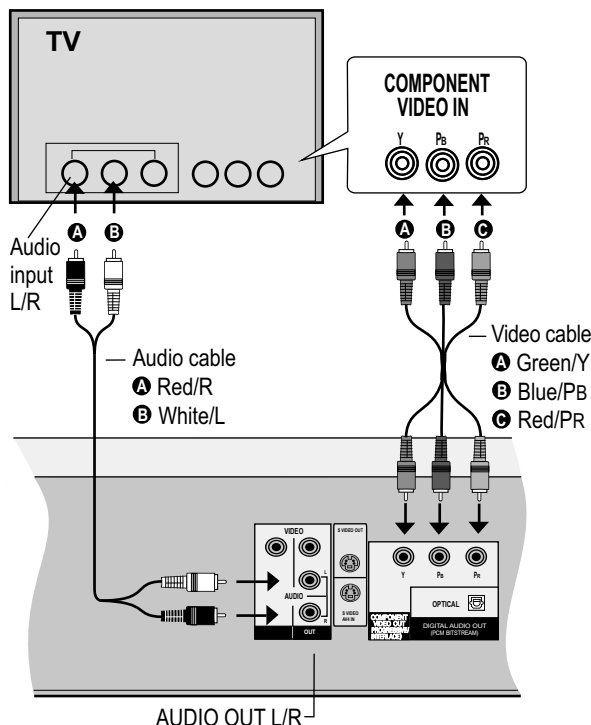

If the AV1 Output setting in the SETUP menu is set to [RGB (without component)], no output will be available from the COMPONENT VIDEO OUT sockets. Set this option to [Video (with component)].

If the unit is connected to the television via the VIDEO OUT, the S VIDEO OUT or the AV1 socket, output takes place in the interlace format regardless of the settings.

## Progressive television picture

The progressive aspect ratio (height to width) is set to 16:9. DVD-Video with an aspect ratio of 16:9 will be displayed properly. However, video material with an aspect ratio of 4:3 will be displayed stretched to the right and left. If it is possible to adjust the aspect ratio of your television for progressive images, set the Progressive setting to [On].

46

## Information for Progressive-compatible televisions (PAL)

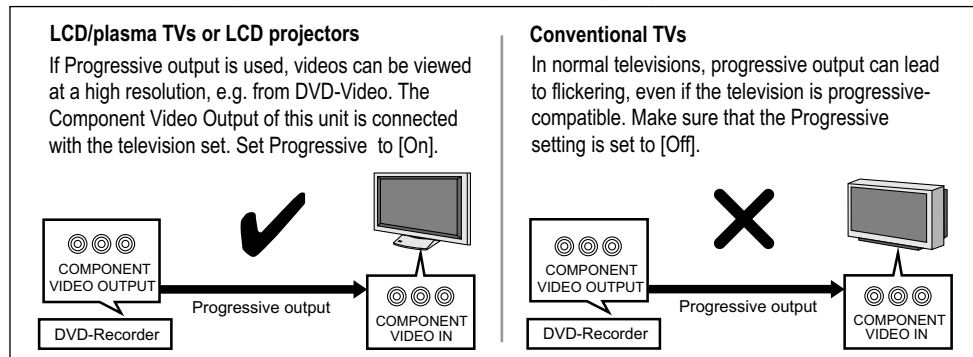



# External devices

## Connecting an analogue amplifier or an analogue system component

In order to enjoy stereo or Dolby Pro Logic, connect the appropriate amplifier or an analogue audio component.

- Connect the analogue output (L/R) e.g. to a Dolby Pro Logic amplifier.
- As described, connect the Audio cable according to the colours and markings of the connection sockets (white/L, red/R).

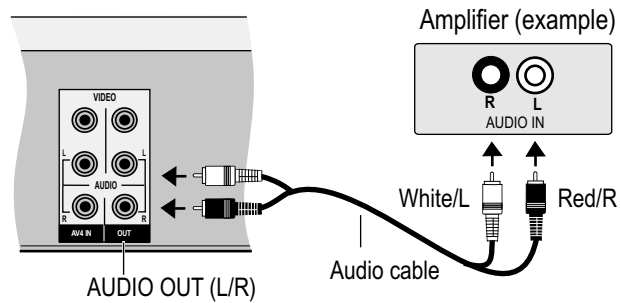

## Connecting a digital amplifier or a digital system component

- Connect an amplifier with a Dolby Digital-, DTS- or MPEG decoder.
- Use an optical digital audio cable.
- In the Sound SETUP menu, change the [Digital Audio Output] setting according to your connected digital amplifier.

45

*You cannot use DTS Digital Surround decoders that are not suitable for DVD.*

**DOLBY DIGITAL** This device can playback stereo sound in Dolby Digital (2 channels). Connect an amplifier with built-in Dolby Digital decoder in order to be able to enjoy Surround Sound.

**DIGITAL SURROUND** Connect this unit to a device with a DTS decoder in order to be able to play DVDs with this symbol.

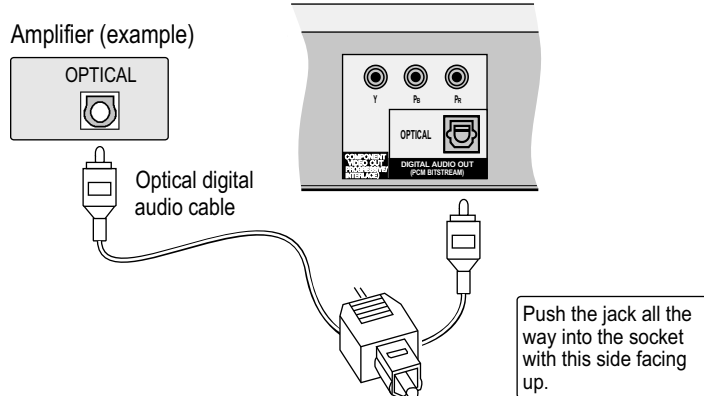

## Connecting to the AV3 input sockets (e.g. Camcorder)

Before you connect the cable, make sure that the power to both devices is turned off. After you have connected the cables, switch both devices on.

If the audio output of the other device is mono, connect it to the L/MONO socket. Both the left and the right channels will be recorded if the connection is made via the L/MONO socket.

*Choose one of the two connection possibilities.*

*Connection with S VIDEO cable and audio cable (L/R) produces the best quality.*

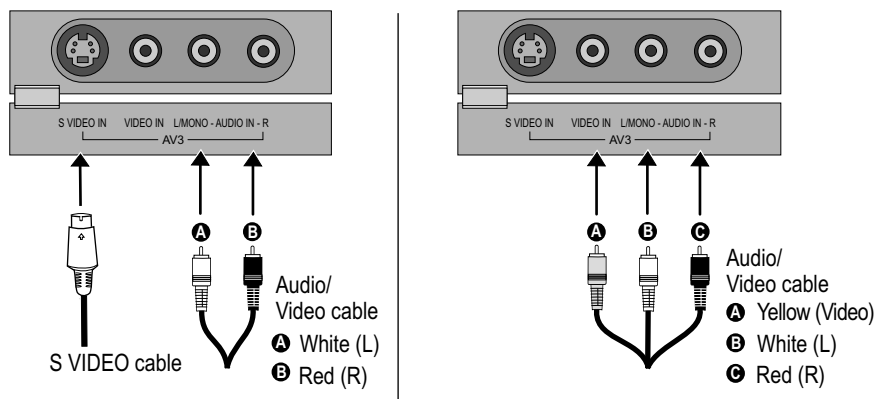

# TV Guide

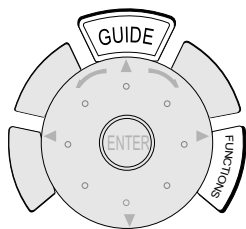

The electronic TV Guide provides a quick overview of the television and radio programmes of your digital stations. The TV Guide provides up to 7 days preview and the option of restricting the display to certain categories like Movies or Sports.

### First use of the TV Guide:

Programme information will be gradually stored on the TV Guide list after completion of Auto Setup or each time mains power to the unit is switched on. This process may take some time due to the nature of broadcast.

*Note: all programme information will be lost when mains power to the unit is switched off.*

### Direct Access:

- Press **GUIDE** on your remote control.  
The TV Guide programme overview is displayed.

### Access via the FUNCTIONS Menu:

- Press **FUNCTIONS** on your remote control.
- Use **▼▲** to select [TV Guide] and press **ENTER**.  
The TV Guide programme overview is displayed.

*The TV Guide is constantly updated in the background. Thus, the display can change during viewing. Analogue channels can be identified by the programme number.*

*Example: 1 BBC 1 - digital station  
901 (A) BBC 1 - analogue station*

*There is no TV Guide information being broadcast for analogue channels.*

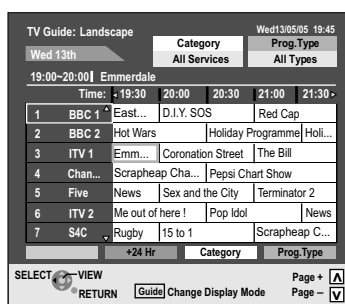

### Launching and Operating the TV Guide

Two convenient TV Guide lists (Landscape view and Portrait view) in which you can select the desired station and display programme information are available in the TV Guide.

#### Landscape view in the TV Guide

- Press **GUIDE** to open the TV Guide.  
The approximate programme start times are shown in the time bar in 30-minute increments. As soon as you select a programme, the programme name and time appear in the line above the time bar.
- Use **▼▲◀▶** to navigate within the TV Guide list.  
Only current and future programmes are shown.
- You can also turn the smart wheel on your remote control to select an item.  
Turning right: Move the cursor keys downwards.  
Turning left: Move the cursor keys upwards.
- Use **PAGE ▲▼** to browse through the TV Guide list.

Jump ahead 24 hours:

- Press the **Green** button to jump ahead by one day.

Jump back 24 hours:

- Press the **Red** button. You can only jump back to the current date.

#### Changing Stations in Landscape view

- Use **▼▲** to select a station.
- To see the current programme press **ENTER**.

*The current programme can be identified by the changed cursor. It is displayed as a yellow frame around the selected entry.*



To switch between Landscape view and Portrait view, press **GUIDE**.

#### Portrait View in the TV Guide

- Press **GUIDE** to open the TV Guide.
- Use **▼▲◀▶** to navigate within the TV Guide list. Only current and future programmes are shown.
- You can also turn the smart wheel on your remote control to select an item.  
Turning right: Move the cursor keys downwards.  
Turning left: Move the cursor keys upwards.
- Use **PAGE ▲▼** to browse through the TV Guide list.

Jump ahead 24 hours:

- Press the **Green** button to jump ahead by one day.

Jump back 24 hours:

- Press the **Red** button. You can only jump back to the current date.

#### Changing Stations in Portrait View

- Use **◀▶** to select a station.
- To see the current programme press **ENTER**.

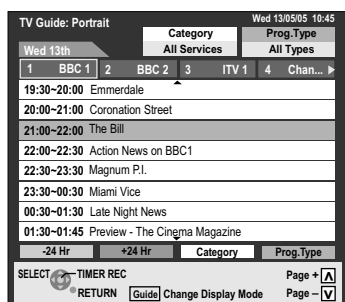
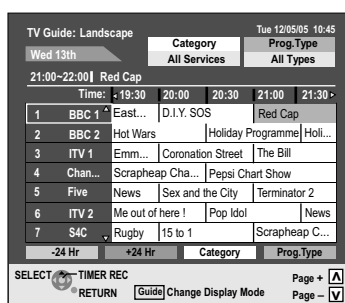

# TV Guide

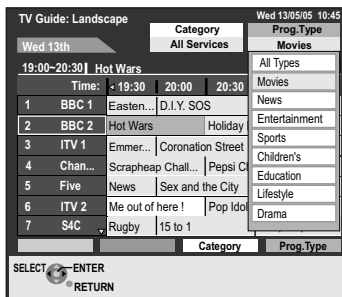

## Selecting the programme from Prog. Type in the TV Guide

- Press **GUIDE** to open the **TV Guide**.

The Programme Type function lets you display a TV Guide list sorted by programme types (e.g. Movies, Sports).

- Press the **Blue** button to display the list of programme types.
- Use **▼▲** to select the desired programme type.  
You may choose between:  
All Types, Movies, News, Entertainment, Sports, Children's, Education, Lifestyle, Drama.
- Make your selection (e.g. Movies) and press **ENTER**.

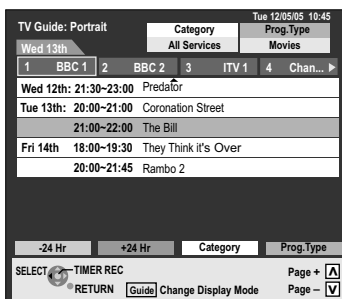

The programme guide is modified according to your selection.

All programme data is displayed in Landscape View. The inapplicable data is greyed out. Only the programmes that match your selection are displayed in Portrait View.

- Use **▼▲◀▶** to go through the TV Guide list.
- To exit the list, press **RETURN**.

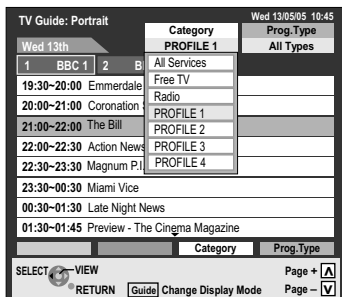

## Selecting the programme from Category in the TV Guide

- Press **GUIDE** to open the **TV Guide**.

The Category function lets you display a TV Guide list sorted by main category (e.g. Free TV, Radio).

In an edited profile, you can compile and sort the stations that you prefer to watch. You can only select the categories PROFILE 1 through PROFILE 4 if you have edited them first.

42

- Press the **Yellow** button to display the list of main category.
- Use **▼▲** to select the desired main category.  
You can choose between:  
All Services, Free TV, Radio, PROFILE 1, PROFILE 2, PROFILE 3, PROFILE 4
- Use **▼▲** to make your selection (e.g. PROFILE 1) and press **ENTER**.
- Use **◀▶▼▲** to go through the TV Guide list.
- To exit the list, press **RETURN**.

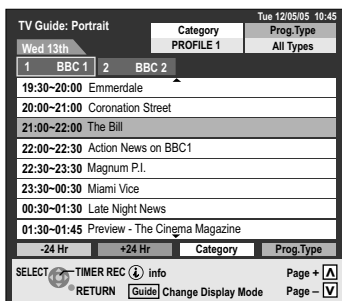

*If you change the Category in the TV Guide, the selected Category is also retained after you exit the TV Guide.*

*If you disconnect the unit from AC mains or switch to standby in Quick Start [Off] mode, the programme information data is cleared and need to be reloaded after Power ON.*

**This DVD Recorder is for viewing and recording free to view channels only, not pay TV or encrypted channels.**

## Handling Discs



Only play round discs.

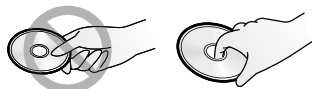

Do not touch the recording surface of the disc.

### Handling Discs

If the surface of a disc that does not have or was removed from a cartridge is damaged, scratches, dirt, dust or fingerprints can compromise the recording, editing or playback. Such damage can also occur when the disc is inserted back into the cartridge.

### Cleaning the DVD-RAM

Clean the disc with a special DVD-RAM cleaner (optional) and read the cleaner instructions thoroughly before use.

### Cleaning DVD-Videos, Video CDs and CDs

If the disc is dirty, wipe it with a moist and then a dry cloth. Bad scratches and stubborn dirt may not be able to be removed so that recording, editing or playback is still compromised even after cleaning. The disc should then no longer be used. Do not use benzine, alcohol, water, cleaning sprays, household cleaners or other solvents.

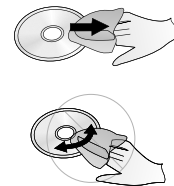

### DVD lens cleaner Compatible models

Only for Panasonic's DVD recorders. Do NOT use this cleaner with any other Panasonic DVD products or with the DVD products of any other companies since doing so may damage the products.

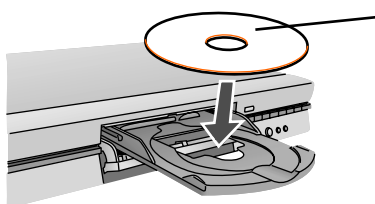

Place the disc in the tray with the label facing upwards.

With double-sided discs, place the side that you want to play, with the label facing up.

### Note:

Only the label side of the disc may be written on. Use a soft oil-based felt pen. Do not use a ball-point pen or other hard writing instrument. Do not affix any stickers or labels to the disc. The disc can warp and may become unusable.

When not in use, place the disc in its jewel case or cartridge so that it does not become scratched or dirty.

Do not drop the disc, place them on top of each other

and never bang them. Do not place anything on top of the disc.

Protect the disc from dirt, dust, heat, humidity, direct sunlight or strong temperature fluctuations (since condensation water can form).

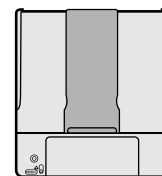

Cartridge

## Disc formats

### RAM Cartridge discs

When the write-protection device is activated, you can neither record nor edit or delete the contents of a disc.



Cartridge write protection  
Remove 8cm discs from the cartridge before you use them on the unit.

### DVD-Video Recording Format (VR)

This format enables the free editing of recordings. Digital programmes that allow "one time only recording" can be recorded once on a CPRM-compatible DVD-RAM. Playback is only possible on compatible units.

### DVD-Video Format (V)

This format corresponds with the commercially available DVD-Video. Recordings made with this unit must be finalised in order to be played back on a DVD player. Digital programmes that allow "one time only recording" can not be recorded. The DVD-Video format can be recorded on DVD-R or DVD-RW.

### RAM CPRM (Content Protection for Recordable Media)

This unit is compatible with the copy-protection system CPRM for writable media. When using a CPRM-compatible disc, a digital programme can be recorded one time. Programmes broadcast with this copy-protection system cannot be recorded on DVD-R or 2.8GB DVD-RAM.



### Regional codes (DVD-Video only)

DVD-Videos with the regional code 2 or ALL can be played with this unit.

The code is listed on the backside of the unit.

England and Continental Europe: 2.

***This DVD Recorder is for viewing and recording free to view channels only, not pay TV or encrypted channels.***

## Disc formats

**RAM** The disc can only be played back on DVD-RAM-compatible players.

**RAM** You can use the playback and the DIRECT NAVIGATOR while the unit is in timer-standby mode.

**R** **RW** **R** After the recording is complete, it takes approx. 30 seconds for the unit to finish the recording information. The first 30 seconds of a recording may be missing if you perform several **TIMER**-controlled recordings in a row.

Discs recorded with PAL or NTSC signals:

TV type	Disc	Yes/No
Multi-system TV	PAL	Yes
	NTSC	Yes
NTSC-TV	PAL	No
	NTSC	Yes
PAL-TV	PAL	Yes
	NTSC	Yes (PAL60)

In order to playback a DVD-R, DVD-RW (DVD-Video format) or +R recorded using this unit on another unit, the disc may need to be finalised.

The disc may also not be able to be played back on other units even after finalising.

New or previously used (e.g. in computers) DVD-RAMs or DVD-RWs may need to be formatted before recording with this unit.



This unit cannot play discs that contain PAL and NTSC signals. Discs that were recorded on another unit with PAL and NTSC signals may not be able to be played back.

### Discs that cannot be played back:

Some DVD-R; DVD+R; DVD-R DL; DVD+R DL; DVD-RAM (2.6 GB/5.2 GB); DVD-ROM; CD-ROM; CDV; SVCD that do not conform to IEC62107; SACD; MV-Disc; PD; Photo CD; DivX Video Disc, Blu Ray etc. The playback of non-standard video CDs is not guaranteed.

## Before playback

Due to the disc programme structure set by the manufacturer, not all described functions may be able to be used.

Depending on the disc type, the regional code and the recording conditions, it may not always be possible to play the discs listed.

## Playback and recording discs

	DVD-RAM	4.7GB / 9.4GB, 12cm 2.8GB, 8cm rewritable	<b>RAM</b>	TIME SLIP function, CPRM compatible, supports 2 channel sound, 16:9 format, creation of playback lists, deleting individual titles frees up storage space
	DVD-R (DVD-Video format)	4.7GB, 12cm 1.4GB, 8cm writable	unfinalised <b>R</b> finalised <b>DVD-V</b>	
---	+R	4.7GB, 12cm writable	unfinalised <b>R</b> finalised <b>DVD-V</b>	
	DVD-RW (DVD-Video format)	12cm / 8cm rewritable	unfinalised <b>RW</b> finalised <b>DVD-V</b>	



## Playback discs





	DVD-Video	12cm / 8cm playback only	<b>DVD-V</b>	High-quality video and music discs.
	DVD-Audio	12cm / 8cm playback only	<b>DVD-A</b>	Music discs in digital quality. Playback in 2-channel sound.
	DVD-RW (DVD-VR format)	12cm / 8cm playback only	<b>RW</b>	Unfinalised CPRM compatible discs with "one time only recorded" recording. Recorded on another DVD Recorder.
---	+RW	12cm / 8cm playback only	<b>DVD-V</b>	Recorded on another DVD Recorder. The disc must be finalised eventually.
	Audio CD CD-R/RW	12cm / 8cm playback only	<b>CD</b>	Music and audio recordings.
---		12cm / 8cm playback only		Music in MP3 format, pictures in JPEG and TIFF format. Max. 999 titles / 99 groups.
	Video CD, SVCD CD-R/RW	12cm / 8cm playback only	<b>VCD</b>	Music and video recordings. SVCD conforming to IEC62107.

# Playback

Switch the unit on.



## Playback

- Press **OPEN/CLOSE**  to open the disc tray.
- Place the disc in the disc tray.
- Press **PLAY** .  
The disc tray is closed and playback begins.  
*The reading of the disc may take some time!*

**RAM**  **R**  **RW**  **R**  **RW**  Playback begins with the last recorded title.

**DVD-A**  **DVD-V**  **VCD**  **CD**  Playback begins at the beginning of the disc.

## PAUSE during playback



- Press **PAUSE**  during the playback.
- Press **PAUSE**  again to resume playback.

## Cancelling playback



**RAM**  **R**  **RW**  **R**  **RW** 

- Press **STOP**  during the playback to watch TV via the unit's tuner.







**DVD-A**  **DVD-V**  **VCD**  **CD** 

- Press **STOP**  during the playback. A Screen appears on TV.
- Press **STOP**  again to watch TV via the unit's tuner.

## Resuming playback

- Press **STOP**  during the playback. The unit saves the position.  
*The position is deleted if you switch the unit off.*
- Press **PLAY**  to resume playback from the saved position.
- To cancel the function, press **STOP**  several times.

## A menu appears on the television screen

- **VCD** Use the numeric buttons to select an entry.  
e.g.: number 5:  +  or number 15:  + 
- **DVD-A** **DVD-V** Use   or the numeric buttons to select an entry and confirm with **ENTER**.  
*If  appears on the television screen, this function is not possible at the moment.*

The operation of the disc menu depends on the inserted disc. If you launch the main menu with **TOP MENU**, another menu may appear than when you press **SUB MENU**.



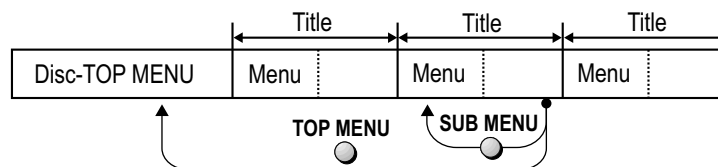







- Use the numeric buttons or   to select the desired entry and confirm with **ENTER**.



## Direct playback

Starting the playback from a selected Title, Chapter or Track.

- During playback, use the numeric buttons to select the desired entry.

5:  +  15:  +  **MP3** **JPEG** 5:  +  +  15:  +  + 

**DVD-A** While the screensaver is displayed, you can enter a group number.  
*This function is not available for some discs if playback is stopped.*

# Playback

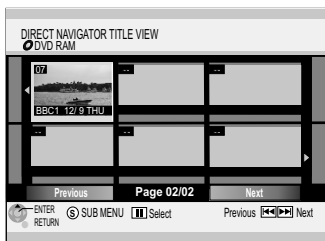

## Selecting programmes/titles for playback

RAM R RWVW R RWVW

You can display the menu during playback, recording and in stop mode using the **DIRECT NAVIGATOR** button.

- Press **DIRECT NAVIGATOR**.
- Use **▼▲▶◀** to select the desired title and confirm with **ENTER**.
- Press **RETURN** to exit the menu.  
You can select other pages using **SKIP ◀◀ Previous** or **▶▶ Next**.

SLOW/SEARCH



## Slow-motion playback

Not CD

- Press **SLOW/SEARCH ◀▶** in pause mode.
- Speed can be controlled in 5 stages.
- Press **PLAY ▶** to resume normal playback.

RAM R RWVW R The pause function is automatically switched on after 5 minutes.

VCD Only for forwards direction. DVD-A Only motion pictures

## Fast forward/rewind

- Press **SLOW/SEARCH ◀▶** during playback.  
As long as the button is pressed, the search speed increases in 5 stages.
- Press **PLAY ▶** to resume playback.

You can change the search speed also by turning the Smart Wheel.

RAM R RWVW R Sound is only output at the first fast-forward speed.

DVD-A MP3 CD In the case of DVD-Audio (except motion picture parts), CD and MP3, sound is output in all speed levels.



## Skipping chapters, titles or pictures

- Press **SKIP ◀◀▶▶** during playback or pause to skip chapters, titles or pictures.

## ◀|||▶ Single-frame playback

Not CD

- Press **◀|||▶** in pause mode.  
Each press of the button shows the next or the previous frame.
- Press **PLAY ▶** to resume playback.

VCD Only for forwards direction.



## Quick View (Play/ x1.3) RAM

Increase playback speed without negative effects on sound.

- Press and hold **PLAY ▶** during playback.
- Press **PLAY ▶** again to return to normal playback speed.

Output takes place in PCM with a digital connection.

Quick View is cancelled if **SKIP ◀◀▶▶**, **▶▶▶** or **PAUSE |||** is pressed or playback of a programme begins that was not recorded with Dolby Digital.

Quick View does not function during simultaneous recording and playback in XP or FR mode.

# Playback



## Splitting a recording into chapters RAM

- Press **CREATE CHAPTER** during playback.
- During playback press **SKIP** or **SKIP** to skip the chapter.*

MANUAL SKIP



## MANUAL SKIP

- Press **MANUAL SKIP** during playback.  
The playback jumps ahead approximately 30 seconds.

TIME SLIP



## TIME SLIP RAM -R -RWV +R -RWVR

- Press **TIME SLIP**.
- Use **▲▼** to select the time that the playback should jump forward or back.  
If you press and hold the buttons, the time span increases or decreases minute-by-minute.  
If you hold the button, it increases or decreases in 10-minute units.
- Press **ENTER** to confirm the selected time.
- Press **PLAY** to hide the picture in picture.

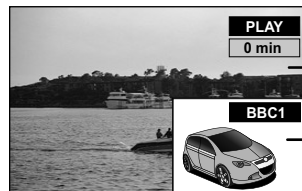

The TV picture is shown as picture-in-picture.

Playback picture

Currently received picture (receive channel).  
The receive channel can be switched using the **CH ▲, ▼** button.  
This is not possible during a recording.

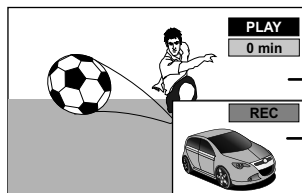

Playback started 30 seconds ago.

Image currently being recorded.

## Delayed playback RAM

Playback can be started while the unit is still recording.  
Without stopping the current recording, you can view the recording from the beginning.

- Press **STOP** to end the playback.
- After 2 seconds, press **STOP** again to stop the recording.  
Use **TIMER** to stop a **TIMER**-controlled recording.



# MP3 playback

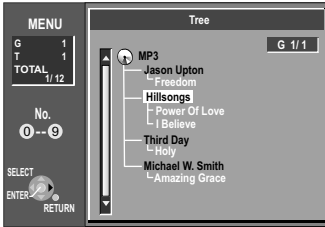

## CD (MP3)

This unit can play MP3 files that were recorded with a computer on a CD-R/RW. Files are captured as tracks and folders as groups. "TOTAL" includes all tracks in all groups of the disc.

- Use **DIRECT NAVIGATOR** to launch the MENU screen.
- Use **▲▼** to select the desired track and confirm with **ENTER**. Playback continues until the last track of the selected group.  
To select a track via the numeric buttons, press e.g. for track no. 8: 0 0 8 .
- Use **DIRECT NAVIGATOR** or **RETURN** to exit the MENU screen.

**Use SKIP** ◀◀, ▶▶ **to select other tracks/groups or pages.**  
After all tracks in a group have been displayed, the next group is listed.

### Selecting a group using the tree structure

- After selecting a track in the file list, press **▶**. The tree structure appears on the screen.
- Use **▲▼** to select the desired group.
- Use **◀▶** to switch between different levels in the screen of the tree structure.
- Confirm with **ENTER**. The selected group is displayed in the file list.
- Use **▲▼** to select the desired track and confirm with **ENTER**.

- ☞ Shows the track currently being played.
- G**: Group number
- T**: Track number in the group
- TOTAL**: Selected track number / Total number of track numbers
- No.:** Selected group number
- Group**: Selected group name

### Notes on JPEG/MP3 format

- The discs must correspond with the formats ISO 9660 Level 1 or 2 and Joliet.
- Compatible compression rate: between 32 kbps and 320 kbps
- Compatible scan rate: 44.1 kHz and 48 kHz
- Maximum number of recognisable Tracks and groups:  
999 Tracks and 99 groups
- The device is not compatible with ID3-Tags or Packet Writing.
- If there are a lot of still images or Sessions, the readout and playback of the disc can take some time.

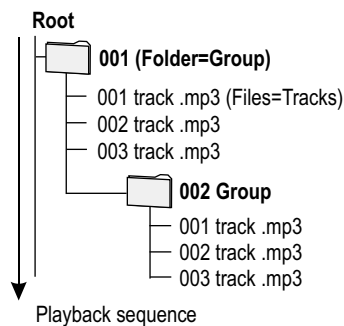

### Notes on pictures (JPEG, TIFF)

Compatible formats: DCF\* compatible (material recorded with a digital camera, etc.)  
\* Design rule for Camera File system: uniform standard of the Japan Electronics and Information Technology Industries Association (JEITA).

File format: JPEG, TIFF (uncompressed RGB chunky format).  
Number of pixels: 34x34 through 6144x4096 (sub-scanning 4:2:2 or 4:2:0).  
The unit can process up to a maximum of 999 files and 99 folders (including higher folders).  
If TIFF-format pictures are to be played back or if there are a lot of files and/or folders, the procedure can take quite some time. Some files may not be able to be displayed or played back. MOTION JPEG is not supported.

# JPEG playback

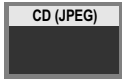
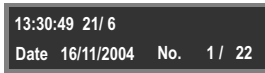
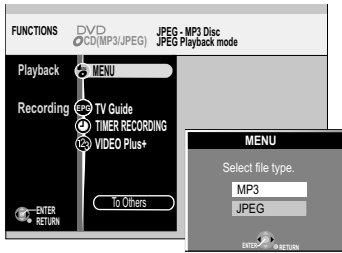

## CD (MP3/JPEG)

The following information on the file type appears at the beginning:  
Playback mode is set to MP3.

Select "JPEG" from MENU in FUNCTIONS if you play pictures ( JPEG ).

- Confirm the information with **ENTER**.
- Press **FUNCTIONS** and confirm MENU with **ENTER**.
- Use **▲▼** to select the desired file type and confirm with **ENTER**.

## Displaying the picture properties

- Select the desired picture and press **ENTER**.
- Press **STATUS** twice.
- Press **STATUS** again to exit the display.

## CD (JPEG)

- Press **DIRECT NAVIGATOR**. The PICTURE (JPEG) VIEW appears on the screen.
- Use **▼▲◀▶** to select the desired picture and start picture playback using **ENTER**.
- Use **STOP ■** or **DIRECT NAVIGATOR** to return to PICTURE (JPEG) VIEW.  
*To select a picture using the numeric buttons, press e.g. for picture no. 8: ⑧ ⑧ ⑧ .*

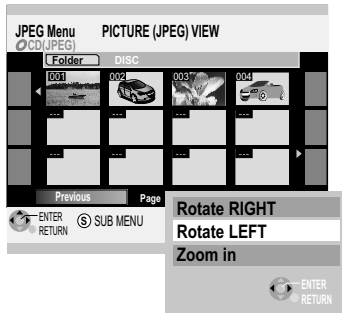

## Rotating pictures

- Press **SUB MENU** during playback.
- In the sub menu, use **▲▼** to select the desired setting and confirm with **ENTER**.
- Use **STOP ■** or **DIRECT NAVIGATOR** to return to PICTURE (JPEG) VIEW.

## Zoom in / Zoom out (Only for pictures smaller than 640 x 480 pixels)

- Press **SUB MENU** during playback.
- In the sub menu, use **▲▼** to select [Zoom in] and confirm with **ENTER**.
- To switch back to the original size, confirm [Zoom out] with **ENTER** in the sub-menu.

## Selecting a Folder

- In PICTURE (JPEG) VIEW, use **▲▼** to select [Folder].  
If you confirm [Folder] with **ENTER**, you can use **▲▼** in the following menu to select the desired Folder and confirm with **ENTER**.

## Slide Interval

- Press **SUB MENU**.
- Use **▲▼** to select [Slide Interval] and confirm with **ENTER**.
- Use **◀▶** to select the display duration of the individual pictures in the Slide Show.
- Confirm with **ENTER**.

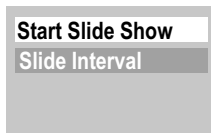

## Start Slide Show

- Press **SUB MENU** again and confirm [Start Slide Show] with **ENTER**.  
The pictures in the folder are displayed in the selected interval.  
The Slide Show stops after the last picture.  
Use **STOP ■** or **DIRECT NAVIGATOR** to return to PICTURE (JPEG) VIEW.

# Recording

**RAM** **R** **RWV** **R** You can record up to 99 titles on one disc (+R: 49 titles).

If you use an unformatted DVD-RAM, you must format it before the first recording. The recording is saved in free areas on the disc. If there is no more space left on the target drive, you must delete recordings or use a new disc.

When recording dual-channel or multi-audio TV programmes on DVD-R, DVD-RW or +R, only one audio channel can be recorded.

Please select the desired audio channel in advance.

**RAM** If you have activated the write-protection, cancel it.

49

53

## Recording television programmes

- Use **CH** **^**, **v** or the numeric buttons to select the TV channel.
- Use **INPUT SELECT** to select the AV channel for externally connected devices.
- Press **REC MODE** to select the recording mode.
- Press **● REC** to start the recording.
- Press **STOP ■** to stop the recording.

*Up until the recording is stopped, it counts as 1 title. After recording to disc is complete, it takes some time for the unit to process the information for device control.*

**RAM** **R** **RWV** **R** You can only change the channel or the record mode in pause mode. The material is then recorded as a separate title.

## Pause during recording

- Press **PAUSE ■■** to pause the recording.
- Press **PAUSE ■■** again to resume recording. *The title is not divided.*

## One touch recording (OTR)

- During record, press **● REC** on the unit to set recording time (up to 240 minutes). The unit display changes with each press of the button:  
Counter → OFF 30 → 60 → 90 → 120 → 180 → 240 → Counter  
*This is not possible with FLEXIBLE REC or TIMER-controlled recordings.*  
*If you press **STOP ■**, the recording will be stopped and the time setting deleted.*

DIRECT TV REC

**Direct TV recording**

If your television is equipped with analogue tuner and Q Link functionality, you can directly record the programme that you are watching on TV. The programme position shown on the unit automatically switches to the appropriate TV programme.

- Press **DIRECT TV REC** for 3 seconds. The recording begins.
- Press **STOP ■** to end the recording.

*If the station transmits teletext information and the Title Page is set properly, the programme and station names are recorded automatically. Launching the titles with this unit can take approx. 10 minutes and may fail in some cases.*

## Q Link

*If you have an IDTV with EPG (electronic programme guide) function for digital broadcast, you can perform timer recording using the EPG function. Refer to the televisions operating instructions for further informations.*

## Playback during recording **RAM**

During recording, you can start playback from the beginning of the programme.

- Press **PLAY ►** during the recording or TIMER-controlled recording.  
*The playback can only begin if at least 2 seconds have passed since the start of the recording.*

## Simultaneous recording and playback **RAM**

- Press **DIRECT NAVIGATOR** during the recording or TIMER-controlled recording.
- Use **◀▶▲** to select a title and confirm with **ENTER**.
- Press **DIRECT NAVIGATOR** without selecting a title again to exit the title view.

*If you start the playback while the unit is in standby mode for a TIMER-controlled recording, the recording will begin at the programmed time.*

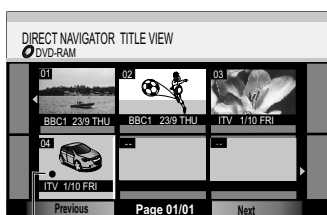

Current recording

# Recording

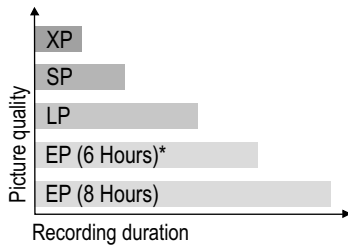

\* Only if the Recording time in EP mode setting in the SETUP menu is set to [EP (6Hours)].

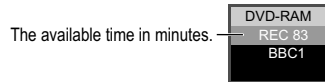

The available time in minutes.

## Recording modes and approximate recording times in hours

	DVD-RAM		DVD+R DVD-RW DVD-R (4.7GB)
	Single-sided (4.7GB)	Double-sided (9.4GB)	
XP (High quality)	1	2	1
SP (Normal)	2	4	2
LP (Long play)	4	8	4
EP (6 Hours)	6	12	6
EP (8 Hours)	8	16	8

When recording on DVD-RAM in EP mode (8 Hours), playback may not be possible on DVD-RAM-compatible DVD players. In this case, select EP mode (6 Hours).

44

## Selecting an audio channel to be recorded in two-channel sound **[R] [RWV] [R]**

- Analogue channels: In the Sound SETUP menu, select the Bilingual Audio Selection [M1] or [M2] setting.
- Digital channels: Select the desired channel in the DISPLAY menu under [DVB Multi Audio].

## FLEXIBLE REC (FR) **[RAM] [R] [RWV] [R]**

The unit calculates the best possible recording quality between XP and EP. It is adjusted to fit the space available on the disc. This function is not possible during an EXT LINK recording.

- In stop mode, press **FUNCTIONS**.
- Use **▲▼** to select [To Others] and press **ENTER**.
- Use **▲▼** to select **FLEXIBLE REC** and press **ENTER**.
- Use **▲▼◀▶** or the numeric buttons to select the required recording time.
- Use **▲▼◀▶** to select [Start] and confirm with **ENTER**. The recording begins.
- Press **RETURN** to exit the **FLEXIBLE REC** window.
- Press **STOP ■** to cancel the recording before the end has been reached. *Neither the channel nor the recording mode can be changed in PAUSE mode.*

## Displaying the available recording time

- Press **STATUS** several times.

# TIMER-controlled recordings



TIMER RECORDING menu for digital channel



TIMER RECORDING menu for analogue channel

## Options in the TIMER RECORDING menu

**Name:** Programme position/name of the TV station

**Date:** You can also programme titles to be recorded on a daily or weekly basis.

**Start:** Start time / **Stop:** Stop time

If you press and hold the **▲▼** buttons, the time increases/decreases in 30-minute increments.

**Mode:** Recording mode (XP, SP, LP, EP, FR)

**STTL:** Subtitles [ON] or [OFF]

Recorded subtitles cannot be switched off later.

*For digital channels PDC cannot be selected.*

**PDC:** [ON] or [---]

**ON :** The station transmits PDC signals. You must set the timer to the time specified in the TV magazines.

**--- :** The station does not transmit PDC signals. Try to set the start and stop time such that the entire film can be recorded even if a programme begins or ends earlier or later than planned.

*For analogue channels STTL cannot be selected.*

*If you selected PDC [ON] recording mode FR is not possible.*

**Programme Name:** You can enter the title of the programme.

34

## PDC function

Programme Delivery Control adjusts the start and stop time of a timer recording automatically to ensure the recording starts and finishes in line with the programme broadcast.

This is useful when a programme over-runs the published times.

The station must be transmitting PDC and the exact time must be set for PDC to work.

The DVD Recorder detects whether a station is transmitting PDC only during the tuning process. If PDC is introduced or discontinued by a station you will need to re-tune the DVD Recorder before it becomes aware of this.

PDC transmissions are not currently nation-wide so please check with your local broadcaster for more information.

# TIMER-controlled recordings

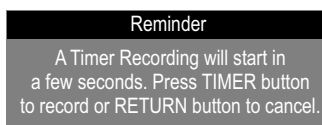
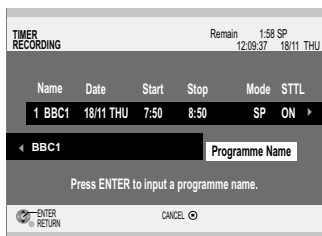
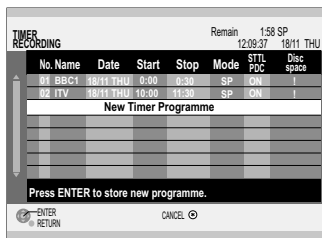

## **PROG/CHECK** Manual programming

- Press **PROG/CHECK**. The TIMER RECORDING screen appears.
- Confirm the highlighted line with **ENTER**.
- Use **▲▼** to select the name of the TV station.
- Use **▶** to switch to the next field and change entry using **▲▼**. Name, Date, Start and Stop can also be entered using the numeric buttons.

- If you want to enter the programme name, use **◀▶** to select [Programme Name] and confirm with **ENTER**.
- Once you have made all changes, save the programme with **ENTER**.
- To continue programming, select [New Timer Programme].
- Press **⊖ TIMER** to switch the unit to TIMER standby mode. The **⊖** symbol lights up in the unit display.
- To cancel or pause the recording, press **⊖ TIMER** again.

34

**RAM** If you record several programmes in a row, the first few seconds of the following programme are not recorded on the disc, **⏮ ⏪ ⏩ ⏭** approx. 30 seconds.

## Reminder

If you enter a TIMER programming and do not switch the recorder to TIMER standby because you want to watch a television programme, then you will be reminded of the pending start 1 minute before the recording starts.

- Press **TIMER** if you want to start the timer recording.
- Press **RETURN** if want to cancel the timer recording.

Even if you forget or don't want to press **TIMER** to switch to TIMER standby, the recorder will start recording. You have to press **RETURN** for cancelling the timer recording.

## **PROG/CHECK** Checking, changing or deleting TIMER RECORDINGS

- Press **PROG/CHECK**.
- Use **▲▼** to select the TIMER RECORDING.

### Checking or changing

Check the settings or correct them if necessary using **ENTER** and **▲▼◀▶**. Confirm your changes with **ENTER**.

Programmes that are currently being recorded cannot be changed.

### Deleting

Delete a programme with **\* CANCEL**.

Programmes that are currently being recorded cannot be deleted.

If you selected PDC [ON], TIMER-controlled recordings are deleted from the list after two days.

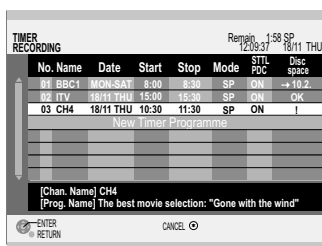

Make sure that the unit is switched to TIMER standby mode.

The **⊖** symbol lights up in the unit display.

## Storage space on the disc

- OK:** There is enough storage space available on the disc for the recording. If PDC is switched on during the recording, then the entire programme will probably not be recorded.
- (Date):** For recordings that are made daily or weekly, the display indicates whether there is enough storage space on the disc.
- !:** Is displayed if the disc is not in the unit, is write-protected or does not have enough storage space.

# TIMER-controlled recordings

## TIMER RECORDING in the TV Guide

You can select a programme that you want to record in the TV Guide list and transfer it directly to the TIMER RECORDING menu.

- Press **GUIDE** to open the TV Guide.
- Select the desired programme with **▼▲◀▶** in the TV Guide list.
- Press **ENTER**. The TIMER RECORDING menu appears on the screen with the information on the selected programme.  
Name, Date, Start, Stop and Programme Name are taken from the TV Guide.
- Use **◀▶** to select Mode. You can change the recording mode with **▼▲**.
- Use **◀▶** to select STTL. You can change the setting with **▼▲**.
- You can manually change Name, Date, Start and Stop of the recording by selecting them with **◀▶** and changing them using **▼▲**.

28

To manually change the name of the programme you like to record select [Programme Name] using **◀▶** and press **ENTER**. The Programme Name screen appears. After you have changed and set your programme name, the TIMER RECORDING screen appears again.

34

- Press **ENTER** to save and return to the TV Guide list.
- Press **TIMER** to switch the unit to TIMER standby mode.  
The TIMER symbol **⌚** appears in the display. The TV Guide list can still be launched by pressing the **GUIDE** button.

Programmes programmed with **TIMER RECORDING** have the symbol **T** in the TV Guide list.

A currently running programme cannot be transfer to the **TIMER RECORDING** menu with **ENTER**. Such programmes can be identified by the changed cursor. It appears as a yellow frame around the selected entry. If you want to record a programme that is currently running, launch the **TIMER RECORDING** menu and perform the entries manually or press **REC**.

*Encrypted programmes are not marked in the TV Guide. If you record an encrypted programme, you will only see a black screen with a banner when you replay the recording.*

*If you record in a programme which only contains MHEG data, again only a black screen is recorded.*

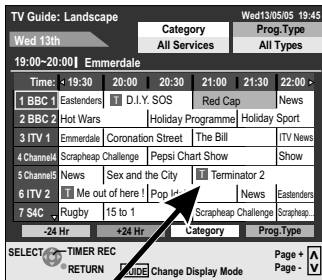
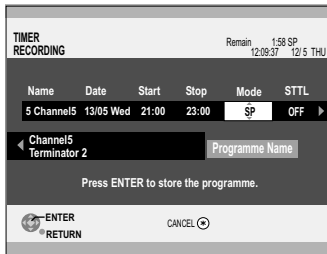

**T** This programme is programmed in the **TIMER RECORDING** menu.

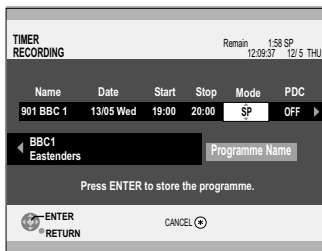

## TIMER RECORDING from analogue channels

No digital EPG data exists for analogue stations. A **TIMER** programming needs to be made manually.

29

**This DVD Recorder is for viewing and recording free to view channels only, not pay TV or encrypted channels.**

# TIMER-controlled recordings

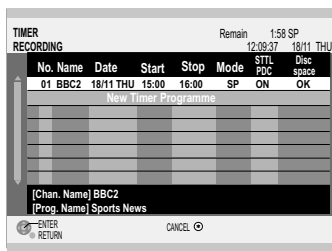
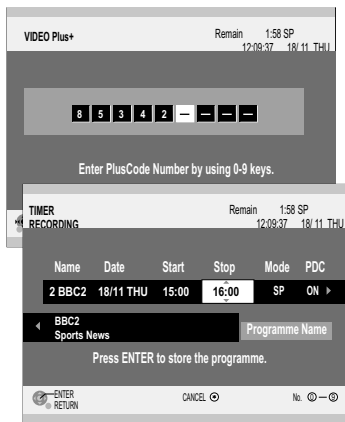

**RAM** **RR** **RWWW** **RR** You can programme up to 16 programmes per month in advance. Insert a disc.  
*VIDEO Plus+ is not supported for digital channels.*

## VIDEO Plus+ Programming recordings with VIDEO Plus+

By entering a VIDEO Plus+ number, the TIMER-controlled recording is easy to set. The appropriate codes can be found in newspapers and TV guides.

- Press **VIDEO Plus+**.
- Enter the VIDEO Plus+ number using the numeric buttons. Use **◀** to delete a number.
- Confirm the VIDEO Plus+ number with **ENTER**.

In the TIMER RECORDING screen, check the start and end time and the PDC signal.

If [---] is displayed under Name, use **▲▼** to select the desired programme position.

- Use **◀▶**, **▲▼** to select the recording mode. (XP, SP, LP, EP, FR)  
If you selected PDC [ON], recording mode FR is not possible.
- If you want to enter the programme name, use **◀▶** to select [Programme Name] and confirm with **ENTER**.
- Once you have performed all changes, save the programme with **ENTER**.
- To continue programming, select [New Timer Programme].
- Press **⏸** **TIMER** to switch the unit to TIMER standby mode. The **⏸** symbol lights up in the unit display.
- To cancel or pause the recording, press **⏸** **TIMER** again.

*VIDEO Plus+ and PlusCode are registered trademarks of Gemstar Development Corporation. The VIDEO Plus+ system is manufactured under license from Gemstar Development Corporation.*

## TIMER recording from Sat with VIDEO Plus+

### VIDEO Plus+ Codes for Satellite Receivers

This DVD Recorder is not designed to control (switch on or change channel) your satellite receiver, however, it can be taught to recognise VIDEO Plus+ Codes for Satellite stations. The Satellite Receiver must be switched on and the correct station selected.

Some receivers have their own timer facility for this purpose.

Please refer to your Satellite Receiver instructions for use of such timer facilities.

For your DVD Recorder to recognise the VIDEO Plus+ Codes for each satellite station, you must teach your DVD Recorder which channel or AV input to record from for the first time. Otherwise when setting a VIDEO Plus+ recording, the [- -] symbol will appear in the channel position indicating that the DVD Recorder does not know which channel position to set.

Once you have set the channel/AV input the DVD Recorder will remember it whenever you use a VIDEO Plus+ Code for the station again.

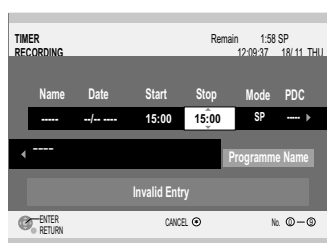
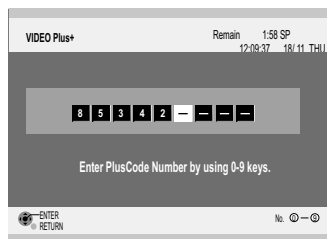

VIDEO Plus+

- Press the **VIDEO Plus+** button.
- Enter a VIDEO Plus+ Code from a Satellite TV Guide for a satellite channel, e.g. Sky 1 using the **Numeric** buttons. Press **◀** to correct any mistakes.
- Press the **ENTER** button. [- -] will appear instead of a channel number/AV input.
- Press the **CH** button to select the channel or AV input that is to be used for recording from the satellite channel.
- Press the **ENTER** button to memorise the setting. The DVD Recorder will now automatically set the programme position or AV input correctly when a VIDEO Plus+ recording is set for this satellite station in the future.
- Press **▲▼** to select the programme that you have just set. Now press the **CANCEL/RESET** button to delete it from the timer recording list. It is no longer needed.
- Repeat the steps above until you have set and deleted dummy timer recordings for each of the satellite stations that you will make VIDEO Plus+ recordings from.
- Press **RETURN** when you have finished.

## TIMER-controlled recordings

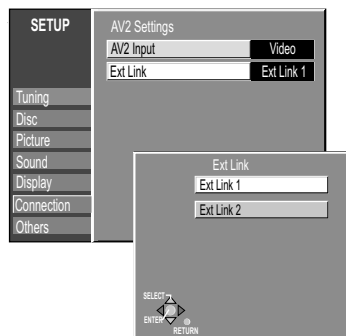

### Ext Link 1:

For digital receivers that send a special recording control signal, e.g. the SKY SATELLITE RECEIVER.

### Ext Link 2:

External recording control for satellites or digital receivers (video signal).

If the television is connected to the AV1 connection via the 21-pin Scart cable, the picture to be recorded appears on the screen.

The beginning of the recording may not be recorded correctly in certain cases.

The Ext Link 2 setting cannot be used if the input signal is in NTSC format.

### Before TIMER recordings via external devices

You control the recording function via an external device (e.g. receiver) using **EXT LINK**. Connect the external device with a 21-pin Scart cable to the AV2 socket.

Adjust the Ext Link function for the connected device.

- Press **FUNCTIONS**, use **▼▲** to select [To Others] and press **ENTER**.
- Use **▼▲** to select **SETUP** and press **ENTER**.
- Use **▼▲** to select **Connection**, **▶**, **▼▲** to select **AV2 Settings** and press **ENTER**.
- Use **▼▲** to select **Ext Link** and confirm with **ENTER**.
- Use **▼▲** to select [Ext Link 1] or [Ext Link 2] and confirm with **ENTER**.

### TIMER recordings via external devices (EXT LINK)

The programming of the recording must take place on the external device. The recording begins when a corresponding signal is received from the connected device and ends when the transmission of the signal is stopped.

- Press **EXT LINK**. Standby mode for TIMER-controlled recordings is activated. EXT Link lights up on the display.

*If you have activated the External Link Standby mode, remote control functions such as the TV Guide are not available.*

### Switching off control via the external device

- Press **EXT LINK** to end the recording or to switch off the standby mode for the TIMER-controlled recording. The EXT Link display turns off.

## Recording from an external device, e.g. a camera

**RAM** **⊖R** **⊖RWM** **⊕R** Connect the external device to the AV3 input sockets on the front side of the unit.

**RAM** If you activated the write-protection, deactivate it.

Choose one of the two connection possibilities.

Connection with S VIDEO cable and audio cable (L/R) produces the best quality.

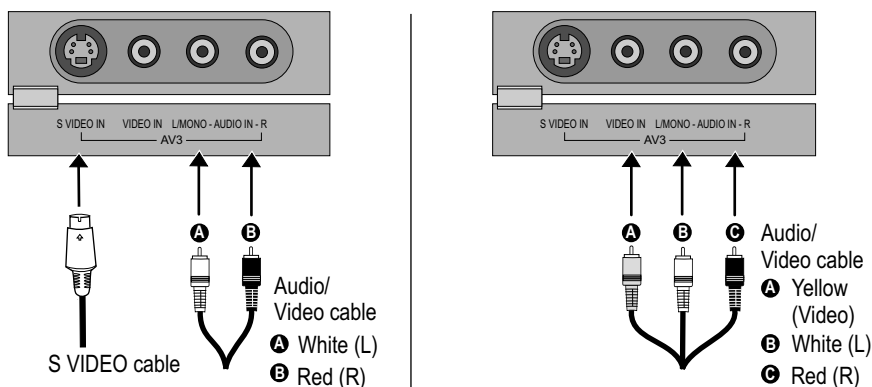

- Press **REC MODE** to select the recording mode.
- In stop mode, use **INPUT SELECT** to select the input channel AV3.
- Start the playback on the external device.
- Press **● REC** at the point where you want to begin recording.
- Press **PAUSE** **||** to pause recording. Press the button to resume recording.
- Press **STOP** **■** to stop recording.

*This unit cannot record signals from PCs.*

### Recording of bilingual programmes:

**RAM** If [M1] and [M2] are selected on the connected device, you can choose the audio mode during playback.

**⊖R** **⊖RWM** **⊕R** Select [M1] or [M2] on the connected device. You cannot select the audio mode during playback. If the output signal of the external device is an NTSC signal, set the TV system in the **SETUP** menu to [NTSC].



# FUNCTIONS Selection Menu

You can access the main functions via the FUNCTIONS selection menu.

The illustrations show DVD-RAM menus.

The menu entries can be different depending on the disc or medium. MP3&JPEG 25 - 26

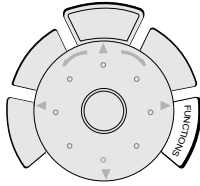

- Press **FUNCTIONS** in stop mode.
- Use **▼▲** to select a menu and confirm with **ENTER**.
- Use **▼▲** to select an option and confirm with **ENTER**.
- To view the second screen page, use **▼▲** to select [To Others] and confirm with **ENTER**.
- To return to the first page, use **▼▲** to select [Return] and confirm with **ENTER**.
- Press **FUNCTIONS** to exit the selection menu.

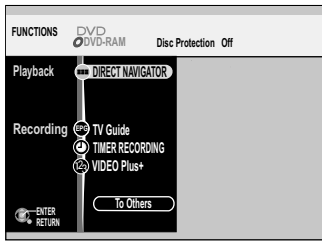

DIRECT NAVIGATOR	Edit titles and chapters, protect recordings.	<span style="border: 1px solid black; padding: 2px;">35 - 37</span>
TV Guide	Your electronic programme guide	<span style="border: 1px solid black; padding: 2px;">18 - 19</span>
TIMER RECORDING	Programme recordings	<span style="border: 1px solid black; padding: 2px;">27 - 32</span>
VIDEO Plus+	Programme recordings with VIDEO Plus+	<span style="border: 1px solid black; padding: 2px;">31</span>
<span style="border: 1px solid black; border-radius: 15px; padding: 2px 10px;">To Others</span>		<i>Open the 2nd screen page</i>

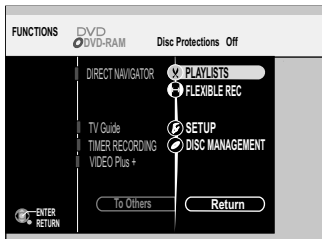

PLAYLISTS	Create and edit playlists.	<span style="border: 1px solid black; padding: 2px;">38 - 40</span>
FLEXIBLE REC	Automatic selection of the recording mode.	<span style="border: 1px solid black; padding: 2px;">28</span>
SETUP	Change the unit's default settings.	<span style="border: 1px solid black; padding: 2px;">41 - 48</span>
DISC MANAGEMENT	Format and finalize discs, write protection.	<span style="border: 1px solid black; padding: 2px;">49 - 50</span>
<span style="border: 1px solid black; border-radius: 15px; padding: 2px 10px;">Return</span>		<i>Back to 1st screen page</i>

# FUNCTIONS Selection Menu

## Symbols

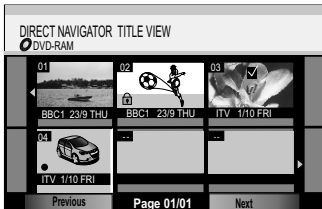
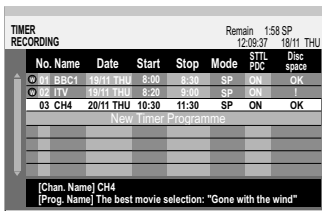

- This title is currently being recorded.
- Ⓜ The title overlaps other programmes.
- Ⓣ The disc was full or the highest number of titles or scenes was reached so that the programme could not be recorded.
- 🔒 The title is write-protected.
- 🔒 The television programme was copy-protected so that the programme could not be recorded.
- ✗ The programme cannot be played back due to damaged data or cannot be recorded for another reason.
- ☑ The title is selected.

**N** (NTSC)   **P** (PAL)

The title or the playlist was recorded with a TV system other than that currently set in the unit. Titles and playlists with these markings cannot be played back. Switch your TV system to play back these titles/playlists.

46

## Editing several elements

- Use **▼▲◀▶** to select the desired title and press **PAUSE** **|||**. A tiek **☑** appears. Repeat this process to select other titles.
- Press **PAUSE** **|||** again to cancel.

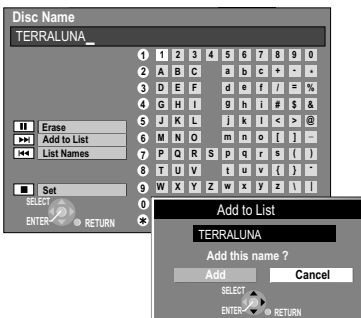

## Entering Text **RAM** **•R** **•RWV** **•R**

You can give discs or programmes titles in various menus: In DISC MANAGEMENT, in DIRECT NAVIGATOR, in the PLAYLIST and when setting the TIMER-controlled recording.

## Entering a Disc Name or Title via the Menu

- Use **▲▼◀▶** to select the desired character and confirm with **ENTER**.
- Use **PAUSE** **|||** to delete a letter.
- If you want to save the name/title in the List Names, press **SKIP** **▶▶▶**.
- Use **◀** to select [Add] in the next screen and confirm with **ENTER**.
- If you press **STOP** **■**, the name/title is saved.

## Entering a Title via the Numeric Buttons, For Example: the Letter "R"

- Press [7] to go to the 7th line.
- Press [7] twice to select "R" and confirm with **ENTER**.



## Erasing a Disc Name or Title from List Names

- Use **◀◀◀ SKIP** to open List Names.
- Use **▼▲◀▶** to select the title or name and press **SUB MENU**.
- Confirm [Erase Name] with **ENTER**.
- Use **◀** to select [Erase] in the next screen and confirm with **ENTER**.

## Selecting a Disc Name or Title from List Names

- Use **◀◀◀ SKIP** to open List Names.
- Use **▼▲◀▶** to select the disc name or title confirm with **ENTER**.

# FUNCTIONS Selection Menu



## DIRECT NAVIGATOR

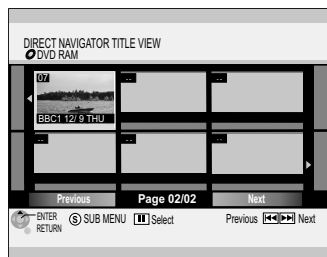

In DIRECT NAVIGATOR, you can archive, edit or start recordings after selecting a title.

### Direct access:

- Press DIRECT NAVIGATOR on the remote control. The DIRECT NAVIGATOR is displayed.

### Access via the FUNCTIONS menu:

- Press **FUNCTIONS** in stop mode.
- Confirm DIRECT NAVIGATOR with **ENTER**. Use **▼▲◀▶** [Previous] or [Next] to select other pages and press **ENTER**.
- Select the desired title and start playback with **ENTER**.

You can also enter the title with the numeric buttons. If you enter a number that is larger than the total number of the title, then the last title is selected.

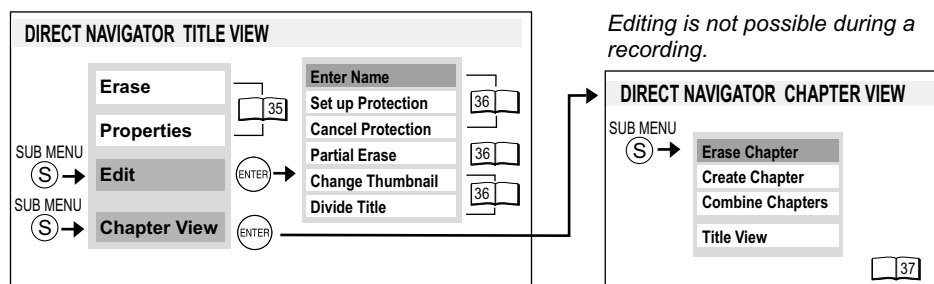

Editing is not possible during a recording.

## Editing Titles and Chapters with the SUB MENU

- Press **SUB MENU**.  
You can access further sub menus with **SUB MENU**.
- In the sub menu, use **▲▼** to select the desired option and confirm with **ENTER**.
- Use **RETURN** to go back to the TITLE VIEW.
- Press **RETURN** again to exit the screen.

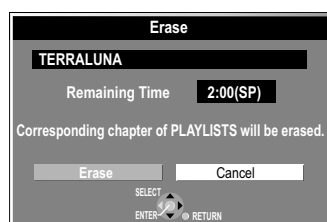
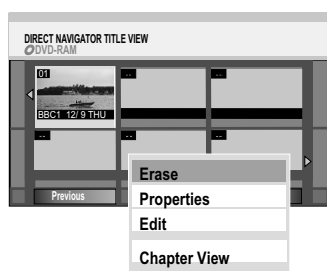

### Erase **RAM -R -RWV +R**

When you perform this procedure, the title is deleted and cannot be recovered.

- Confirm [Erase] with **ENTER**.
- Use **◀** to select [Erase] and confirm with **ENTER**.

The available recording time may remain the same after erasing short titles. The recording time on DVD-R/+R remains the same.

To edit several elements, use **▼▲◀▶** to select the desired title and press **PAUSE** **||**.



### Properties **RAM -R -RWV +R -RW(VR)**

Information on the playback list, e.g. time and date, is displayed.

- Use **▼▲** to select [Properties] and confirm with **ENTER**.

**Edit**  36

**Chapter View**  37

# FUNCTIONS Selection Menu



## DIRECT NAVIGATOR

Erase	
Properties	
Edit	Enter Name
Chapter View	Set up Protection
	Cancel Protection
	Partial Erase
	Change Thumbnail
	Divide Title

- Press **FUNCTIONS**.
- Confirm DIRECT NAVIGATOR with **ENTER**.
- In the TITLE VIEW menu, use **▼▲◀▶** to select the desired title.
- Press **SUB MENU**.
- In the sub menu, use **▼▲** to select [Edit] and confirm with **ENTER**.

### Enter Name **RAM -R -RWV) +R**

The complete name is displayed in the sub menu [Properties].

- Confirm [Enter Name] with **ENTER**.
- Change or enter the title of the programme.

34



### Set up Protection, Cancel Protection **RAM**

- Use **▼▲** to select [Set up Protection] or [Cancel Protection] and confirm with **ENTER**.
- Use **◀** to select [Yes] and confirm with **ENTER**.

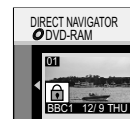

To edit several elements, use **▼▲◀▶** to select the desired title and press **PAUSE**.

### Partial Erase **RAM**

Before you start erasing, make sure that you really want to erase the recordings.

- Use **▼▲** to select [Partial Erase] and confirm with **ENTER**.
- At the desired start point, confirm [Start] with **ENTER**.
- At the desired end point, confirm [End] with **ENTER**.
- Confirm [Next] with **ENTER**.
- In the following screen, use **◀** to select [Erase] and confirm with **ENTER**. After the erase procedure, you can select the next start and end point.
- Confirm [Next] again with **ENTER**.
- Use **▼▲** to select [Erase] and press **ENTER**.
- To exit the menu, use **▼▲** to select [Exit] and press **ENTER**.

Use **PAUSE** and **SKIP** to jump to the beginning or end of a title.

You can search for begin and end points with **SLOW/SEARCH** or **TIME SLIP**.

You may not be able to detect begin and end points if they are less than 3 seconds apart or if the recorded picture was a still image. The unit switches to pause, when the end of the track is reached. The available recording time on the disc may remain the same after the erase process.

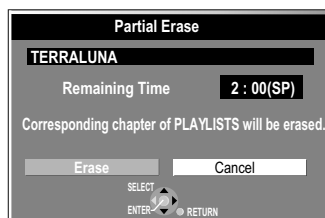

### Change Thumbnail **RAM -R -RWV) +R**

You can select an image to be displayed as a preview in the title view.

- Use **▼▲** to select [Change Thumbnail] and confirm with **ENTER**.
- Press **PLAY** to start the playback.
- Press **ENTER** at the image that you want to display.
- Confirm [Exit] with **ENTER**. The displayed preview is exchanged for this image.

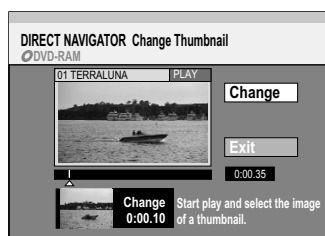

### Divide Title **RAM**

You can divide a selected title. A divided title cannot be recombined again.

- Use **▼▲** to select [Divide Title] and confirm with **ENTER**.
- With **SLOW/SEARCH** and **PAUSE**, find the spot where you want to divide the title and confirm [Divide] with **ENTER**.
- Confirm [Preview] with **ENTER**. The playback will take place 10 seconds before to 10 seconds after the dividing point.
- Use **▼▲** to select [Exit] if you want skip the preview.
- Confirm [Exit] with **ENTER**.
- In the Divide Title screen, use **◀** to select [Divide] and confirm with **ENTER**.

This function cannot be used if the resulting sections are extremely short or if the total number of the title is more than 99 (DVD-RAM).

A short section of the recording right before the dividing point can be lost.

The divided titles have the same name as the original title.

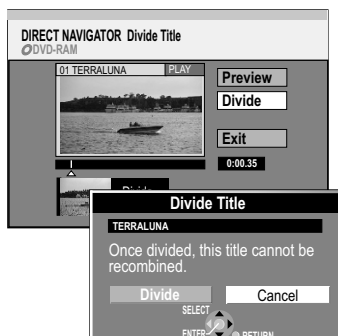

# FUNCTIONS Selection Menu



## DIRECT NAVIGATOR

### Chapter View

- In the sub menu, use **▼▲** to select [Chapter View] and confirm with **ENTER**.
- In the CHAPTER VIEW menu, use **▼▲◀▶** to select the desired title.
- Press **SUB MENU**, use **▼▲** to select the desired option in the sub menu and confirm with **ENTER**.

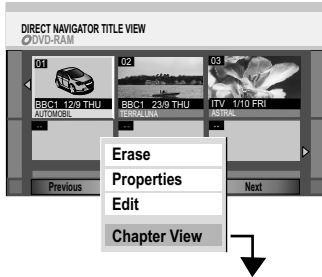

### Playing back chapters

- Press **SUB MENU** in DIRECT NAVIGATOR.
- Use **▼▲** to select Chapter View and confirm with **ENTER**.
- Use **▼▲◀▶** [Previous] or [Next] to select additional pages and press **ENTER**.
- Select the desired chapter and start playback with **ENTER**.

### Editing chapters

- In the CHAPTER VIEW menu, use **▼▲◀▶** to select the desired chapter.
- Press **SUB MENU**.
- Use **▼▲** to select the desired option and confirm with **ENTER**.

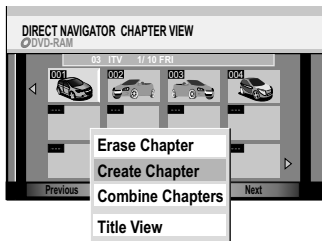

### Erase Chapter **RAM**

- Confirm [Erase Chapter] with **ENTER**.
- Use **◀** to select [Erase] and confirm with **ENTER**.  
*To edit several elements, use **▼▲◀▶** to select the desired title and press **PAUSE** ■■*

### Create Chapter **RAM**

- Use **▼▲** to select [Create Chapter] and confirm with **ENTER**.
- Press **ENTER** where you want to create the chapter.
- Repeat this step to create more chapters.
- Use **▼** to select [Exit] and confirm with **ENTER**.

*A short section of the recording right before the diving point may be lost.*

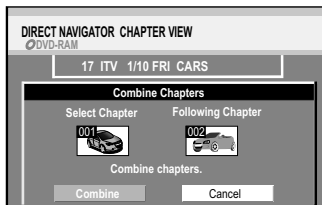

### Combine Chapters **RAM**

- Use **▼▲** to select [Combine chapters.] and confirm with **ENTER**.  
The selected chapter will be combined with the following chapter.
- Use **◀** to select [Combine] and confirm with **ENTER**.

**Title View:** Return to TITLE VIEW.

# FUNCTIONS Selection Menu

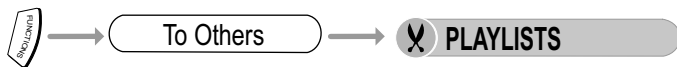

You can create and then edit a playlist from your favourite chapters of your recording.  
**RAM** Insert a recorded disc.  
 If write protection is activated, deactivate it.

## Creating a Playlist

- Press **FUNCTIONS** in stop mode.
- Use **▼▲** to select [To Others] and confirm with **ENTER**.
- Confirm **PLAYLISTS** with **ENTER**.
- In **PLAYLIST VIEW**, use **▼▲◀▶** to select the free [Create] field and confirm with **ENTER**.

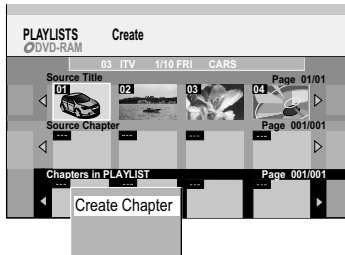

### Create Source Chap.

- In the Create menu, use **◀▶** to select the Source Title and press **SUB MENU**.
- Confirm [Create Chapter] with **ENTER**.
- In the [Create Source Chap.] Menu, use **ENTER** to select the chapter sections.  
 To place an exact chapter marking, use **PAUSE** to stop the playback.  
 Use **SLOW/SEARCH** **◀▶**, **▶▶**, **SKIPI** **◀▶**, **▶▶**, **TIME SLIP** or **◀▶** to select the position.
- Use **▼** to select [Exit] and confirm with **ENTER**.

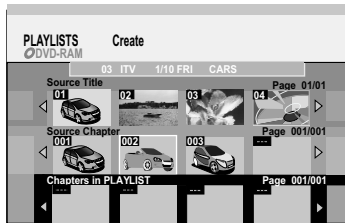

### Adding Chapters to PLAYLISTS

- In the Create menu, use **◀▶** to select a Source Title and use **▼** to go to [Source Chapter].
- Use **◀▶** to select the Source Chapter that you want to add to the playlist and confirm with **ENTER**.
- Use **◀▶** to select the position where the chapter should be inserted into the **PLAYLISTS** and confirm with **ENTER**.
- To add another chapter, repeat the steps. Use **▲** to select additional Source Titles.
- Use **RETURN** to go back to **PLAYLIST VIEW**.  
 If you confirm a selected source title with **ENTER**, the entire title is saved into the **PLAYLISTS**.



## Select / Edit Playlists

- Press **FUNCTIONS**.
- Use **▼▲** to select [To Others] and confirm with **ENTER**.
- Confirm **PLAYLISTS** with **ENTER**.
- Use **▼▲◀▶** to select a playlist.
- You can play the playlist with **ENTER**.

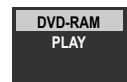

- With **SUB MENU**, the sub menu for editing the playlist appears.

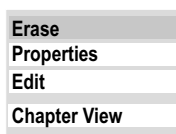

### Erase

- Confirm [Erase] with **ENTER**.
- In the next screen, use **◀** to select [Erase].  
 An erased playlist cannot be restored.
- Confirm [Erase] with **ENTER**

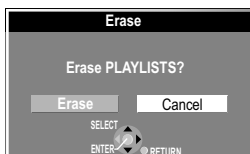

To edit several elements, use **▼▲◀▶** to select the desired title and press **PAUSE**.

### Properties

- Use **▼▲** to select [Properties] and confirm with **ENTER**.  
 Information on the playlist, e.g. chapter and date, is displayed.



**Edit** 39

**Chapter View** 40

# FUNCTIONS Selection Menu

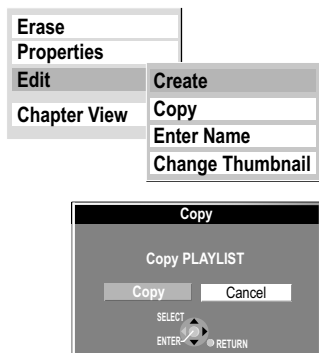
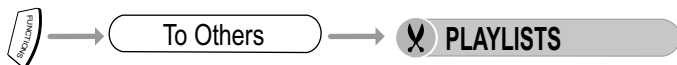

## Edit Playlists

- Press **FUNCTIONS**.
- Use **▼▲** to select [To Others] and confirm with **ENTER**.
- Confirm **PLAYLISTS** with **ENTER**.
- Use **▼▲◀▶** to select a playlist.
- Press **SUB MENU**
- Use **▼▲** to select [Edit] and confirm with **ENTER**.
- In the sub menu, select the desired option.

### Create

- Confirm [Create] with **ENTER**.  
Please read Creating a Playlist.

38

### Copy

- Use **▼▲** to select [Copy] and confirm with **ENTER**.
- In the following screen, use **◀** to select [Copy] and confirm with **ENTER**.

To edit several elements, use **▼▲◀▶** to select the desired title and press **PAUSE** **||**.

### Enter Name

If you enter a long name, it is only partially displayed.

34

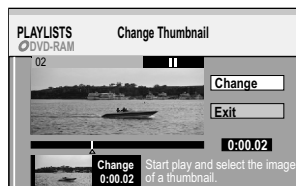

### Change Thumbnail

You can select an image to be displayed as the preview in **TITLE VIEW**. The image will be displayed as the preview for approx. 1 second after the beginning of the title.

- Use **▼▲** to select [Change Thumbnail] and confirm with **ENTER**.
- In the Change Thumbnail menu, press **PLAY** **▶** to start the playback.
- Press **ENTER** at the selected spot.
- Confirm [Exit] with **ENTER**.

The displayed preview is exchanged for this image.

# FUNCTIONS Selection Menu

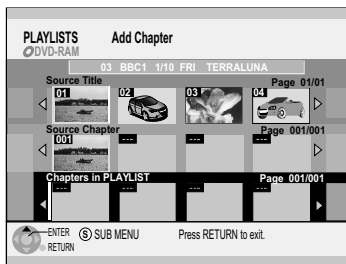
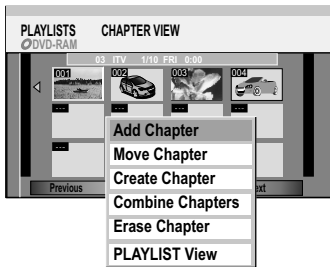
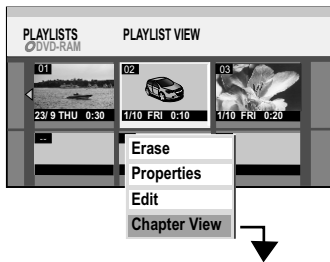

## Edit Chapter

- Press **FUNCTIONS**.
- Use **▼▲** to select [To Others] and confirm with **ENTER**.
- Confirm **PLAYLISTS** with **ENTER**.
- In **PLAYLIST VIEW**, use **▼▲◀▶** to select a playlist.
- Press **SUB MENU**.
- Use **▼▲** to select [Chapter View] and confirm with **ENTER**.

- In **CHAPTER VIEW**, use **▼▲◀▶** to select the desired chapter and press **SUB MENU**.
- In the sub menu, use **▼▲** to select the desired option and confirm with **ENTER**.

## Add Chapter

You can create a new chapter from the Source Title.

- In the [Add Chapter] menu, use **▼▲◀▶** to select a Source Title and press **▼**.
- Use **◀▶** to select a Source Chapter and confirm with **ENTER**. Use **▲** to cancel the process.
- Use **◀▶** to select the position where the chapter is to be inserted and confirm with **ENTER**.
- To add another chapter, repeat the steps. Use **▲** to select other Source Titles.
- Use **RETURN** to go back to **CHAPTER VIEW**.

## Move Chapter

- Use **▼▲◀▶** to select the position where the chapter is to be moved, and confirm with **ENTER**.

## Create Chapter

- Press **ENTER** at the spot where you want to create the chapter. Repeat this step to create a chapter at another spot.
  - Use **▼** to select [Exit] and confirm with **ENTER**.
- A short section of the recording right before the dividing point can be lost.*

*For quick editing*

*Use **PAUSE** and **SKIPI** to jump to the start or end of a title. Find the start and end points with **SLOW/SEARCH** or **TIME SLIP**.*

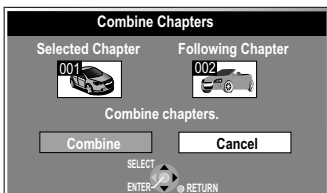
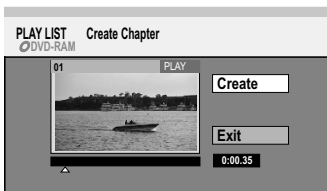
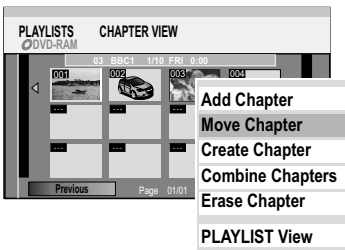

## Combine Chapters

- In the next screen, use **◀** to select [Combine] and confirm with **ENTER**. The selected chapter is combined with the next chapter.

## Erase Chapter

- In the next screen, use **◀** to select [Erase] and confirm with **ENTER**. The original title is not erased by erasing the chapter.
- To edit several elements, use **▼▲◀▶** to select the desired title and press **PAUSE**.*

**PLAYLIST View:** Return to **PLAYLIST VIEW**.



# FUNCTIONS Selection Menu

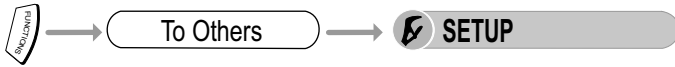

- Press **FUNCTIONS** in stop mode.
- Use **▼▲** to select [To Others] and confirm with **ENTER**.
- Use **▲▼** to select **SETUP** and confirm with **ENTER**.
- Use **▲▼** to select the desired sub menu and use **▶** to switch to setting.
- Use **▲▼** to select the desired setting and confirm with **ENTER**.
- Use **▲▼** to select the desired option and confirm with **ENTER**.

*Follow the menu navigation. The unit saves your settings.*

- Use **◀** to return to the sub menu and use **RETURN** to exit the menu.
- Use **FUNCTIONS** to return to the **FUNCTIONS** menu.

## Menu navigation in the SETUP menu

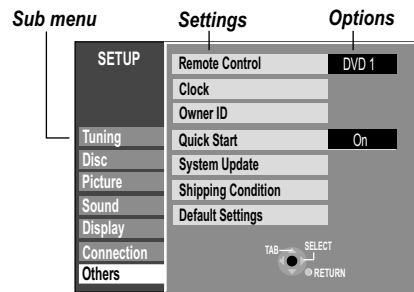
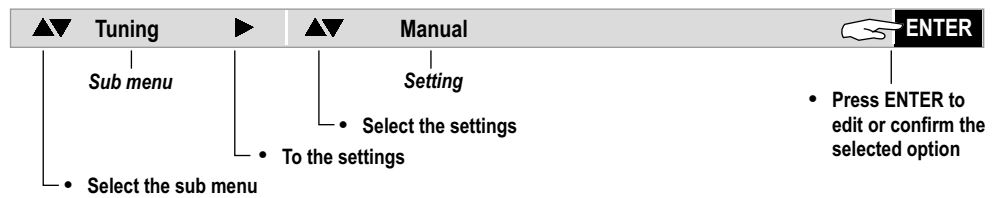

## FUNCTIONS Selection Menu

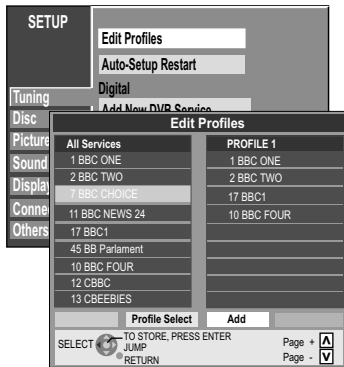

### Creating profiles

You can create four different profiles, in which you can sort and save your desired channels for the TV GUIDE.

- Select [Edit Profiles] and confirm with **ENTER**.  
The Edit Profiles menu appears.
- Press the **GREEN** button to select one of the 4 profiles.
- Use ◀▶ to jump back and forth between the two tables.
- To edit a new profile, use ◀ to go to the left side of the table and press the **GREEN** button.

### Inserting individual channels into the profile.

- Select a new profile.
- Use ▲▼ to select the desired station and press the **YELLOW** button.
- The station is inserted into the profile.
- To insert additional stations, press the **YELLOW** button again.
- Press **ENTER** to save the setting.

### Inserting all available channels into the profile.

- Select a new profile and press the **BLUE** button.  
All channels are inserted into the profile.

### Editing the profile

Use the **GREEN** button to select a profile. To edit the profile, press ▶.

### Profile Name

- Press the **RED** button to change the profile name.  
The letter to be changed is highlighted in red.
- Use ◀▶ to select the desired letters from the row of characters below and use ▲ to go to the next letter to be changed.
- Use the **GREEN** button to add a space and use the **YELLOW** button to delete letters.
- Confirm with **ENTER**.
- To change other profile names, repeat the procedure and save with **ENTER**.

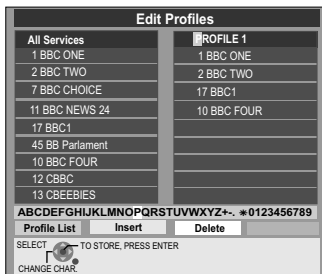

### Move

- Use ▼▲ to select a station in the profile.
- To move the station, press the **GREEN** button.  
The station is highlighted in red.
- Use ▼▲ to select the desired position and press the **GREEN** button again.  
The station is inserted.

### Delete

- Use the **YELLOW** button to delete the station.

### Delete All

- Press the **BLUE** button to delete all stations from the profile.
- Confirm all settings with **ENTER**.

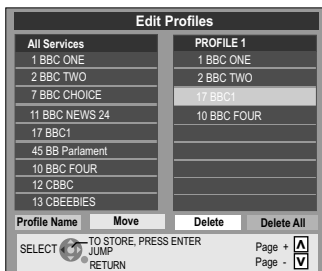

# FUNCTIONS Selection Menu

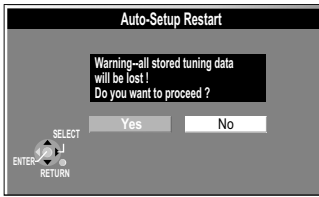
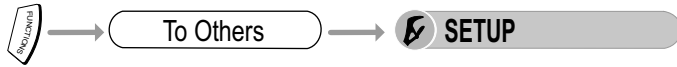

### Auto-Setup Restart

- Use **◀** to select [Yes] and confirm with **ENTER**. The station search begins.
- To cancel the process, use **▶** to select [No] and confirm with **ENTER** or press **RETURN**.
- To stop the station search early, press **RETURN**.

All station settings and all created profiles are deleted during a Restart.



### Add New DVB Service DVB only

The station search begins automatically.

- To stop the station search early, press **RETURN**. The channels found up to the abort of the station search are stored.

The unit searches for new digital stations. At the end of the station search, the number of new digital programmes found is displayed.

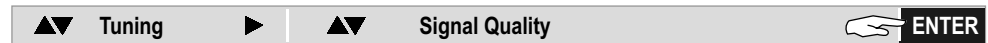

### Signal Quality DVB only

The Signal Quality display shows a bar to indicate the signal quality for digital channels.

- 0 means no signal
- 10 means best signal

If the signal quality is under 50% the colour of the signal bar is red.  
If the signal quality is over 50% the colour of the signal bar is green.

- Use **CH ▲▼** to launch and check the programmes in sequence.

The bar can be started only on digital services. The signal quality button is greyed out on analogue services.

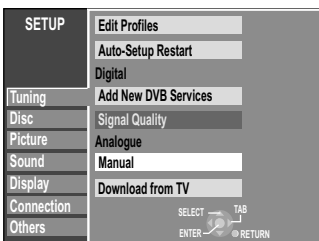

### Entering a new analogue Television Station

- Use **◀▶▲▼** to select an empty station position and confirm **ENTER**.
- Enter the channel using **▲▼** or **⊕ - ⊖**.
- The channel tuning starts. Wait until the desired station is set and confirm the settings with **ENTER**.

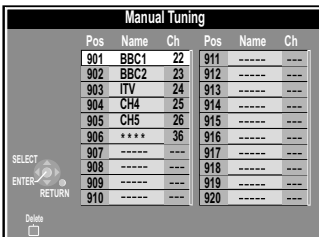

Options available for tuning the channels. Not every model supports all of the functions.		
<b>Pos</b>		Station position.
<b>Name</b>		Station name setting.
<b>Channel</b>		Channel setting.
<b>NICAM</b>	<b>On / Off</b>	Automatic NICAM detection / Mono
<b>Title Page</b>		The station title is obtained from the TV guide.

Your digital channels can be found at positions 1 - 900.

Your analogue channels can be found at positions 901 - 999.

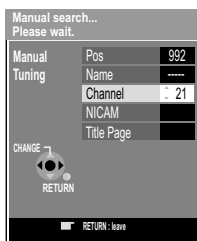

# FUNCTIONS Selection Menu

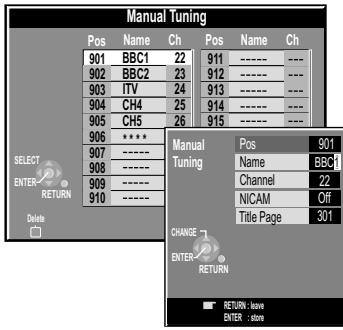
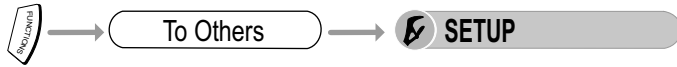

### Changing the Name of the Television Station

- Use **▼▲◀▶** to select the name of the television station and confirm with **ENTER**.
- Use **▼▲** to select [Name] and use **▶** to select the name field.  
The cursor jumps to the first letter **BBC1**.
- Change the letter using **▼▲**.
- Use **▶** to select the next letter **BBC1**.
- Press **ENTER**. The new name is saved in the station table.

### Deleting Television Stations

- Use **▼▲◀▶** to select the station that you want to delete.
- Press the **red** Button to delete the station.  
The settings of the programme position are deleted.

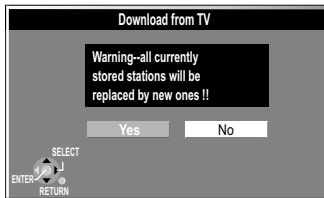

### Download from TV (with Q Link or similar functions)

- Use **◀** to select [Yes] and confirm with **ENTER**.  
The data transfer begins.
- To cancel the process, use **▶** to select [No] and confirm with **ENTER** or press **RETURN**.
- To stop the data transfer early, press **RETURN**.

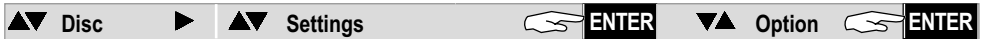
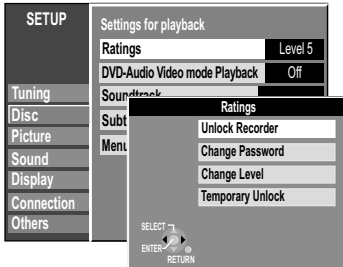

<b>Ratings</b> You can restrict the playback of DVD-Video by entering a password. <b>8</b> Allows all titles. <b>1-7</b> Stops playback of DVD-Video with registered security levels. <b>0</b> Locks all titles.	<b>Changing the Security Level</b> <b>[Unlock Recorder]</b> Return to level 8 <b>[Change Password]</b> Change the password <b>[Change Level]</b> Change the unlock level <b>[Temporary Unlock]</b> You can temporarily unlock a disc for playback. The unit is locked again when you switch to standby or open the disc tray.
--	---

<b>DVD-Audio Video mode Playback:</b> <b>On:</b> You want to play the DVD-Video content of a DVD-Audio. If you change discs or turn the unit off, the setting is reset to [Off].	<b>[On] [Off]</b>
---	-------------------

<b>Soundtrack Subtitle Menus</b> <b>DVD-V</b> Select the language for Soundtrack, Subtitle and Menus. Under [Other], enter the country code for a different language.
--

<b>Recording time in EP mode</b> Select the maximum number of hours for recording in EP mode. <b>EP (6Hours):</b> Recording time on a 4.7GB disc. <b>EP (8Hours):</b> Recording time on a 4.7GB disc. The sound quality is lower.	<b>[EP (6Hours)] [EP (8Hours)]</b>
--	------------------------------------

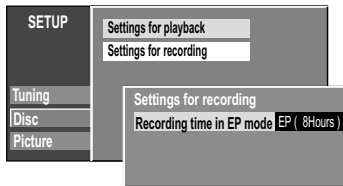

## List of language codes

Abkhazian 6566	Bihari 6672	Esperanto 6979	Hindi 7273	Latin 7665	Oriya 7982	Sindhi 8368	Tigrinya 8473
Afar 6565	Breton 6682	Estonia 6984	Hungarian 7285	Latvian 7686	Pashto 8083	Singhalese 8373	Tonga 8479
Afrikaans 6570	Bulgarian 6671	Faroese 7079	Icelandic 7383	Lingala 7678	Persian 7065	Slovak 8375	Turkish 8482
Albanian 8381	Burmese 7789	Fiji 7074	Indonesian 7378	Lithuanian 7684	Polish 8076	Slovenian 8376	Turkmen 8475
Ameharic 6577	Byelorussian 6669	Finnish 7073	Interlingua 7365	Macedonian 7775	Portuguese 8084	Somali 8379	Twi 8487
Arabic 6582	Catalan 6765	French 7082	Irish 7165	Malagasy 7771	Punjabi 8065	Spanish 6983	Ukrainian 8575
Armenian 7289	Chinese 9072	Frisian 7089	Italian 7384	Malay 7783	Quechua 8185	Sundanese 8385	Urdu 8582
Assamese 6583	Corsican 6779	Galician 7176	Japanese 7465	Malayalam 7776	Rhaeto-Rom. 8277	Swahili 8387	Uzbek 8590
Aymara 6589	Croatian 7282	Georgian 7565	Javanese 7487	Maltese 7778	Romanian 8279	Swedish 8386	Vietnamese 8673
Azerbaijani 6590	Czech 6783	German 6869	Kanada 7578	Maori 7773	Russian 8285	Tagalog 8476	Volapük 8679
Bashkir 6665	Danish 6865	Greek 6976	Kashmiri 7583	Marathi 7782	Samoan 8377	Tajik 8471	Welsh 6789
Basque 6985	Dutch 7876	Greenlandic 7576	Kazakh 7575	Moldavian 7779	Sanskrit 8365	Tamil 8465	Wolof 8779
Bengali 6678	English 6978	Guarani 7178	Kirghiz 7589	Mongolian 7778	Scots Gaelic 7168	Tatar 8484	Xhosa 8872
Bhutani 6890		Gujarati 7185	Korean 7579	Nauru 7865	Serbian 8382	Telugo 8469	Yiddish 7473
		Hausa 7265	Kurdish 7585	Nepali 7869	Serbo-Croat. 8372	Thai 8472	Yoruba 8979
		Hebrew 7387	Laotian 7679	Norwegian 7879	Shona 8378	Tibetan 6679	Zulu 9085

# FUNCTIONS Selection Menu

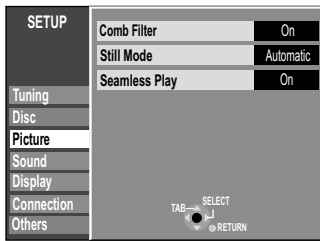

▲▼ Picture ▶ ▲▼ Settings ENTER ▼▲ Option ENTER

**Comb Filter** [On] [Off]

**On:** The picture becomes clear and contour-rich. This setting is always set to [On] if you have selected [TV System - NTSC].  
**Off:** If the picture to be recorded is grainy.

**Still Mode** [Automatic] [Field] [Frame]

Select the display of the still image.  
**Field:** Select this function, if the picture is disturbed with the [Automatic] setting.  
**Frame:** Select this function if small text or line structures are not displayed clearly with the [Automatic] setting.  
*Frames are still images that together form a moving picture. A full frame is made up of 2 half frames. The picture can appear blurry but the overall quality is good. A half frame only contains half of the information of a full frame and has a poorer picture quality.*

**Seamless Play** [On] [Off]

**On:** When playing playlists, the transitions from one chapter to the next are improved. The end and beginning of the chapters can shift slightly and the transition is smooth.  
**Off:** The transitions between the chapters are played as they were recorded. The picture may freeze for a second during the transition.  
*Seamless Play does not work if several audio channels are recorded..*

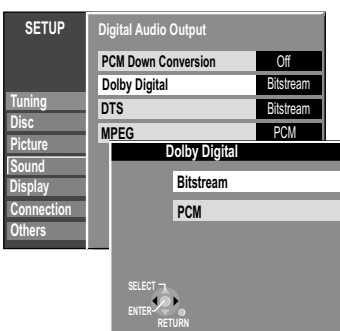
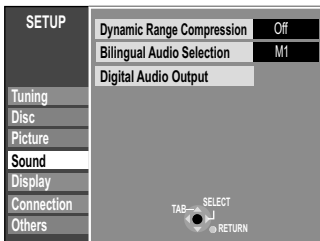

▲▼ Sound ▶ ▲▼ Settings ENTER ▼▲ Option ENTER

**Dynamic Range Compression** **Dolby Digital** (only Dolby Digital) [On] [Off]

**On:** The level of quiet sections is increased and the level of loud sections is decreased. The sound is still clearly audible when the volume is decreased.

**Bilingual Audio Selection** **LR** **RWV** **RR** [M 1] [M 2]

If you want to record programmes on discs that were broadcast in dual channel tone, you can choose between the original language [M 1] or another available language [M 2].  
 If you are copying from an external source or a tape position to disc, select the sound track on the other unit.

**Digital Audio Output** [PCM Down Conversion], [Dolby Digital], [DTS], [MPEG]

Select the appropriate setting if an external unit is connected to the DIGITAL AUDIO OUT of the DVD Recorder.

**PCM Down Conversion** [On] [Off]

Select the audio output mode at a scanning frequency of 96 kHz or 88.2 kHz. Despite this setting, signals are converted to 48 kHz or 44.1 kHz if they have a scanning frequency of more than 96 kHz or 88.2 kHz or a disc is copy-protected.  
**On:** The connected unit cannot process signals with a scan frequency of 96 kHz or 88.2 kHz. Signals are converted to 48 kHz or 44.1 kHz.  
**Off:** The connected unit can process signals with a scan frequency of 96 kHz or 88.2 kHz. Signals are output as 96 kHz or 88.2 kHz.

**Dolby Digital, DTS, MPEG** [Bitstream] [PCM]

**Bitstream:** The connected unit can decode the corresponding signal.  
**PCM:** If the connected unit cannot decode the corresponding signal, the setting must be switched to [PCM]. Otherwise, strong noise can cause damage to hearing or loudspeakers. Perform settings based on your audio system.

# FUNCTIONS Selection Menu



SETUP	DVB Preferred Subtitles	English
	On-Screen Messages	Automatic
	Grey Background	On
Tuning	FL Display	Bright
Disc	New Service Message	Automatic
Picture		
Sound		
Display		
Connection		
Others		

**New Service**

A new DVB service has been found.  
Add to the list of "All Services"?

Yes No

Display	Settings	Option
<p><b>DVB Preferred Subtitles</b> [DVB only]</p> <p>Select the language for DVB Subtitles.</p>		
<p><b>On-Screen Messages</b> [Automatic] [Off]</p> <p><b>Automatic:</b> The screen messages are displayed on the screen.</p>		
<p><b>Grey Background</b> [On] [Off]</p> <p><b>On:</b> The grey background is displayed when there is no television reception.</p>		
<p><b>FL Display</b> [Bright] [Dim]</p> <p>Change the brightness of the unit display.</p>		
<p><b>New Service Message</b> [DVB only] [Automatic] [Off]</p> <p><b>Automatic:</b> New digital stations are constantly scanned in the background. A message is displayed if new stations were found and you can add them to you station list.</p>		

SETUP	TV Aspect	16:9
	Progressive	Off
	TV System	PAL
Tuning	AV1 Output	RGB
Disc	AV2 Settings	
Picture		
Sound		
Display		
Connection		
Others		

Connection	Settings	Option
<p><b>TV Aspect</b> [16:9] [4:3] [Letterbox]</p> <p>Select the TV picture format of your television set. <i>Letterbox: Black bar appear at the top and bottom of your screen.</i></p>		
<p><b>Progressive</b> [On] [Off] Only COMPONENT VIDEO OUT.</p> <p><b>On:</b> In COMPONENT VIDEO OUT mode, the signal is displayed in full picture quality.</p>		
<p><b>TV System</b> [PAL] [NTSC]</p> <p><b>PAL:</b> You connect the unit to a PAL or multi-system television set. Programmes that were recorded with NTSC are played back as PAL60. <b>NTSC:</b> You connect the unit to an NTSC television set. Programmes that were recorded with NTSC are played back as NTSC.</p>		
<p><b>AV1 Output</b> [Video ( with component )] [S Video (with component)] [RGB ( without component )]</p> <p>Switch to RGB for an improved picture quality. If RGB is set, no signal is available at COMPONENT VIDEO OUT.</p>		
<p><b>AV2 Settings</b> AV2 Input, Ext Link</p> <p>Perform the settings in the following sub menus for the connected device.</p>		
<p><b>AV2 Input</b> [RGB / Video] [RGB] [Video] [S Video]</p> <p><b>RGB / Video:</b> Is detected automatically. <b>RGB, Video, S Video:</b> Input is switched to the selected signal.</p>		
<p><b>Ext Link</b> [Ext Link 1] [Ext Link 2]</p> <p><b>Ext Link 1:</b> For digital receivers that send a special recording control signal, e.g. the F.U.N. receiver (TU-DSF41). <b>Ext Link 2:</b> External recording control for satellites or digital receivers (video signal).</p>		

SETUP	TV Aspect	16:9
	Progressive	Off
	TV System	PAL
Tuning	AV1 Output	RGB
Disc	AV2 Settings	
Picture		
Sound		
Display		
Connection		
Others		

SETUP	AV2 Settings	
	AV2 Input	RGB/Video
	Ext Link	Ext Link 1
Tuning		
Disc		
Picture		
Sound		
Display		
Connection		
Others		

<b>AV2 Input</b>	
RGB / Video	
RGB	
Video	
S Video	

# FUNCTIONS Selection Menu

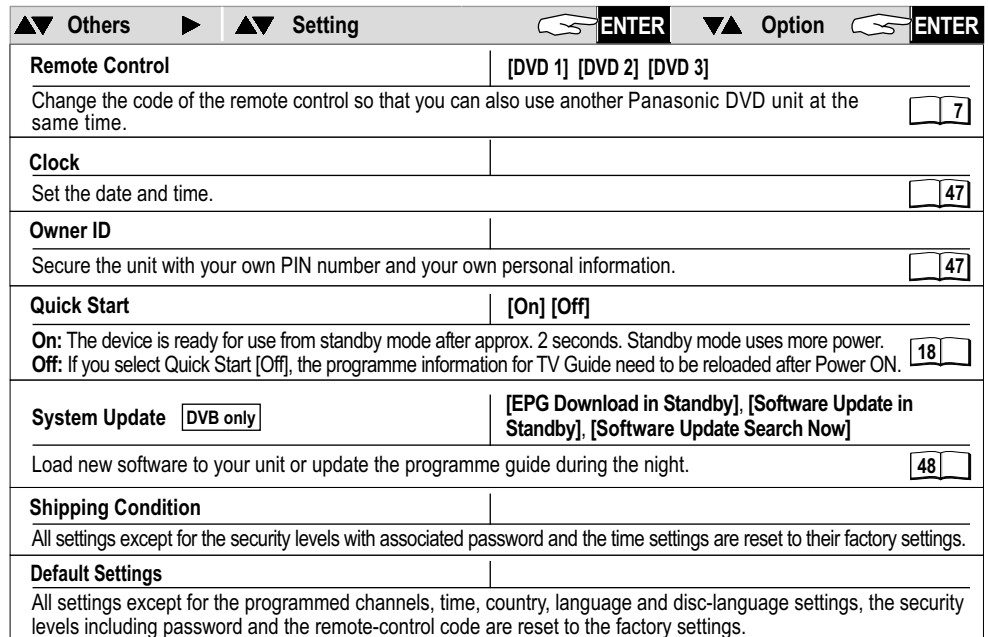
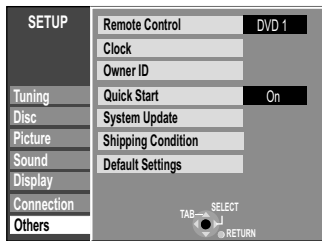

If Clock setting is set to AUTO, do not set it to MANUAL, otherwise the automatic time correction function is deactivated.

This DVD Recorder uses a 24 hour clock. In case of a power failure an automatic back-up system maintains the clock for approximate 60 minutes.

When Clock setting is set to AUTO, the automatic time correction function checks and if necessary adjusts the time several times every day.

The automatic time correction function only works when the DVD Recorder is in standby, it does not work in the timer recording mode. Don't forget to change summer time and winter time.



## Clock setting

The clock will normally be set correctly during Auto-Setup however, in some circumstances the DVD Recorder cannot set the clock automatically. In this case follow the operation steps below to manually set the clock.

- Use ▲ to switch automatic mode to [Off] and confirm with **ENTER**.
- Use ▲▼ and ► to change Time and Date.
- Confirm the change with **ENTER**.

## To activate the automatic time correction function

The correct time for the clock can be automatically maintained when the DVD Recorder is tuned to a station that transmits a time signal.

- Use ▲ to switch automatic mode to [On] and confirm with **ENTER**. The automatic setting of the clock begins.
- Under adverse reception conditions, etc., the Automatic time correction function may not work. In this case the indication for Clock setting is automatically reset to MANUAL. If the reception conditions improve later on, it is possible to activate this function.



## Owner ID

- Use ► and press the Numeric buttons or ▲▼► to enter a four-digit PIN number.
- Press ◀ to correct the digit.
- Press the **ENTER** button twice to confirm.
- Enter the [Name], [House No] and [Postcode] in the same way, using ▲▼◀►.
- Press the **ENTER** button to confirm each entry.
- Press the **RETURN** button to leave the Owner ID screen.

## To display the Owner ID information on TV

- On the unit press **STOP** for more than 5 seconds.

The PIN number is not displayed.

After 30 seconds this menu automatically disappears.

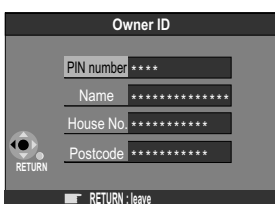

# FUNCTIONS Selection Menu

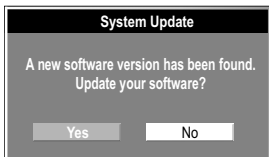
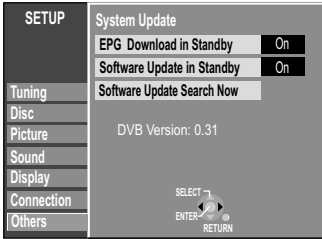

Others	System Update	Option
<b>EPG Download in Standby</b>   [On] [Off]		<p>The unit is permanently looking for EPG data to fill up programme information in the TV Guide as long as it is tuned to a DVB channel, even in standby mode.</p> <p><b>On:</b> An additional "EPG download" during the night is enabled to speed up the loading of data. It will run during one hour between 03:05 am and 05:05 am. During this time "GUIDE" will be shown on the display of the unit.</p> <p><b>Off:</b> No EPG download during the night will be done. The TV Guide screen will not appear if you press the GUIDE button in standby. If the unit is tuned to an analogue channel, no EPG data will be loaded.</p> <p><i>EPG download is only possible if Quick Start is set to [On]. If you press <b>TIMER</b> out of standby for a <b>TIMER</b> recording during EPG download, the <b>TIMER</b> recording will start after the download is finished and not directly.</i></p>
<b>Software Update in Standby</b>   [On] [Off]		<p>In standby mode the unit searches for new software at night between 3:05 am and 5:05 am.</p> <p><b>On:</b> If a new software is found, the download starts automatically. The download procedure lasts appr. 10-15 minutes. During this time "SW-DL" will be shown on the display of the unit. It is recommended not to operate the unit during this time.</p> <p><b>Off:</b> If the setting is set to [Off], no automatic software download is executed.</p> <p><i>If <b>TIMER</b> recordings are programmed for the time between 3:05 am and 5:05 am the automatic software download might not be done. The software download will not be executed if the unit is in EXT Link mode between 3:05 am and 5:05 am.</i></p>
<b>Software Update Search Now</b>		<p>A scan over all digital transponders will be performed to find new software (this search could take up to 10 minutes).</p> <p>If the system finds an update, a message appears on the screen.</p> <ul style="list-style-type: none"> <li>• Press [Yes] to load the new software to your unit. The download takes approximately 15 minutes.</li> <li>• Do not switch your unit off while the update is running. This may result in data loss.</li> <li>• A message appears on the screen when the update is complete.</li> </ul>



# FUNCTIONS Selection Menu

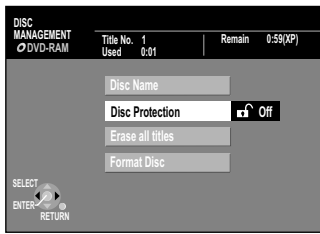

- Press **FUNCTIONS** in stop mode.
- Use **▼▲** to select [To Others] and confirm with **ENTER**.
- Use **▼▲** to select DISC MANAGEMENT and confirm with **ENTER**.
- Use **▲▼** to select the desired menu and confirm with **ENTER**.
- Use **FUNCTIONS** to return to the FUNCTIONS menu.

## Disc Name **RAM** **-R** **-RWV** **+R**

- Enter the name. The name is displayed in the FUNCTIONS window. You cannot give a name to a disc after it has been finalised.



## Disc Protection **RAM**

This procedure allows you to activate or deactivate write protection.

- Use **◀** to select [Yes] and confirm with **ENTER**.  
Write Protection On: The padlock is closed.
- To deactivate write protection, use **◀** to select [Yes] and confirm with **ENTER**.  
Write Protection Off: The padlock is open.

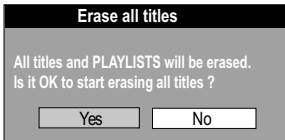

## Erase all titles **RAM**

- Confirm [Erase all titles] with **ENTER**.
- In the following screen, use **◀** to select [Yes] and confirm with **ENTER**. In the confirmation message, use **◀** to select [Start] and confirm with **ENTER**.  
*All titles and PLAYLISTS will be erased and cannot be restored. Protected discs or titles cannot be erased.*

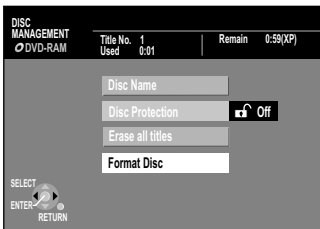

**RAM** If write protection is activated, deactivate it.

- Press **FUNCTIONS** in stop mode.
- Use **▼▲** to select [To Others] and confirm with **ENTER**.
- Use **▼▲** to select DISC MANAGEMENT and confirm with **ENTER**.
- Use **▲▼** to select the desired menu and confirm with **ENTER**.
- Use **FUNCTIONS** to return to the FUNCTIONS menu.

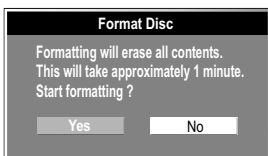

## Format Disc **RAM** **-RWV** **-RWVR**

Some Discs are not formatted. Before you can use them in this unit, they must be formatted. The formatting erases all data on the disc.

- Use **◀** to select [Yes] and confirm with **ENTER**.
- Use **◀** to select [Start] and confirm with **ENTER**.  
The formatting process begins. After it is complete, a message is displayed.
- Press **ENTER**.
- Press **RETURN** to stop the formatting process.

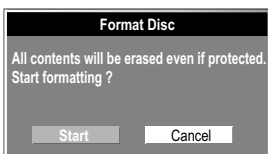

*If the formatting process takes more than 2 minutes, an error may have occurred. The formatting can be cancelled and restarted. Do not unplug the unit while the disc is being formatted. During formatting, all data is erased, including recordings created with this unit. DVD-R/+R and CD-R/RW cannot be formatted.*

# FUNCTIONS Selection Menu

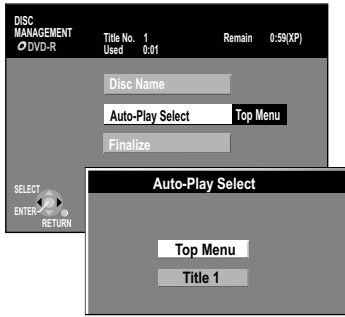
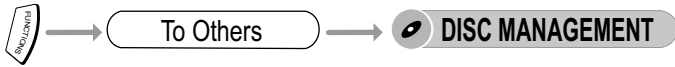

- Press **FUNCTIONS**.
- Use **▼▲** to select [To Others] and confirm with **ENTER**.
- Use **▼▲** to select DISC MANAGEMENT and confirm with **ENTER**.
- Use **▲▼** to select the desired menu and confirm with **ENTER**.
- Use **FUNCTIONS** to return to the FUNCTIONS menu.

### Auto-Play Select **-R -RW/+R**

Before finalisation you must select the start menu to be shown at the beginning of the DVD-V.

- Use **▼▲** to select [Top Menu] or [Title 1] and confirm with **ENTER**.  
*If [Top Menu] is selected, the disc menu appears first.*  
*If [Title 1] is selected, the playback begins at the beginning of the disc.*

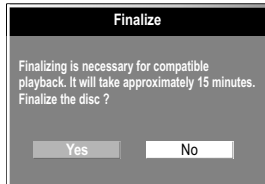

### Finalize **-R -RW/+R**

Finalizing turns DVD-Rs into DVD-Videos in DVD-Video format .

They can be replayed on all DVD players which play the DVD-Video format.

- Use **◀** to select [Yes] and confirm with **ENTER**.
- Use **◀** to select [Start] and confirm with **ENTER**.  
 The finalisation process begins and takes approx. 15 minutes.  
 When this process is finished, a confirmation message appears.
- Press **ENTER**.

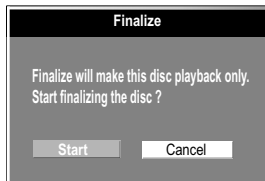

*Do not unplug the unit while the disc is being finalized.*  
*You can only finalize Discs that were recorded on this unit.*  
*You can no longer record to already finalized Discs.*  
*A finalised DVD-RW can be recorded again after reformatting.*

	Before Finalization	After Finalization
Disc display on this device	DVD-R / -RW / +R	DVD-V
Record/edit/enter names	Possible	———
Play on other playback units	———	Possible

# DISPLAY menus

DISPLAY menus contain information on the disc or the unit. With DVD-Video you can use the repeat function, change subtitles and perspectives, with DVD playback, you can change the picture and sound setting.

Depending on the status of the unit (playback, stop), there are some entries that cannot be selected or changed. Subtitles, soundtrack and recording angle can only be selected if they were recorded on the disc. With some discs, these can only be changed via the disc menus. When playing recordings of bilingual programmes, "1+1 ch" is displayed.

- Press **DISPLAY** to launch the menu
- Press **DISPLAY** again to exit the menu.

DISPLAY  ▼▲ Disc ▶ ▼▲ Option ▶ ▼▲ Setting

<b>Disc</b> Soundtrack 1 ENG DD Digital 2/0ch Subtitle Off 1 Eng Angle 1	<b>Soundtrack</b> Soundtrack lang. <input type="text"/> DVD-A DVD-V Change the language by changing the soundtrack.
	Sound properties <input type="text"/> RAM DVD-R DVD-A DVD-V LPCM/PPCm/Dolby Digital, DTS and MPEG signal type k (kHz): scan frequency, b (bit): number of bits ch (channel): number of channels
<b>Soundtrack/ Subtitle Language</b> ENG : English FRA : French DEU : German ITA : Italian ESP : Spanish NLD : Dutch SVE : Swedish NOR : Norwegian DAN : Danish POR : Portuguese RUS : Russian JPN : Japanese CHI : Chinese KOR : Korean MAL : Malay VIE : Vietnamese THA : Thai * : Other	<b>Subtitle</b> Subtitle language <input type="text"/> DVD-A DVD-V Change the subtitle language.
	Subtitles [On] [Off] <input type="text"/> RAM DVD-R DVD-A DVD-V Switch subtitles on or off.
	<b>Angle</b> <input type="text"/> DVD-A DVD-V Select another recording angle.
	<b>STILL-P.</b> Still picture number <input type="text"/> DVD-A Return to standard page: Select [Return] and press <b>ENTER</b> .
	Slide Show Display only
	<b>Audio channel</b> <input type="text"/> RAM L+R/R/L/R Select the audio channel L+R / L / R
	<b>PBC</b> <input type="text"/> VCD PBC displays whether the menu playback control is switched on or off.

DISPLAY  ▼▲ Play ▶ ▼▲ Option ▶ ▼▲ Setting

<b>Disc</b> Repeat Play Off	<b>Repeat Play</b> [On] [Off] This function is only available when the elapsed playtime is displayed.
	<input type="text"/> RAM L+R/R/L/R DVD-V Title Chapter Off <input type="text"/> VCD CD Track All Off <input type="text"/> DVD-A MP3 Track Group Off
	During the playback of playback list <input type="text"/> RAM PL (PLAYLISTS) Off
	<b>If the video CD has playback control</b> <ul style="list-style-type: none"> <li>• Select a track using the numeric buttons in stop mode.</li> </ul>

DISPLAY  ▼▲ Picture ▶ ▼▲ Option ▶ ▼▲ Setting

<b>Disc</b> Playback NR Off Progressive On Transfer Auto	<b>Playback NR</b> [On] [Off] Reduces noise and image distortion.
	<b>Progressive</b> [On] [Off] Switch the COMPONENT VIDEO OUT connection to progressive output.
<b>Transfer</b> PAL output signal [Auto] [Video] Select Video if the Auto setting disrupts the video content. NTSC output signal [Auto1] [Auto2] [Video] Select Video if Auto1 or Auto2 settings disrupt the video content.	

DISPLAY  ▼▲ Sound ▶ ▼▲ Option ▶ ▼▲ Setting

<b>Disc</b> DVB Multi Audio 1 ENG V.S.S. Off Dialog Enhancer Off	<b>DVB Multi Audio</b> <input type="text"/> DVB only If more than one audio channel is broadcast, you can set the desired channel here (only applies to digital channels).
	<b>V.S.S.</b> [Natural] [Emphasis] [Off] <input type="text"/> RAM L+R/R/L/R DVD-V DVD-A Surround sound effect with 2 front loudspeakers. Only with Dolby Digital with 2 or more channels. Switch V.S.S. off if this leads to disturbances. V.S.S. does not work when recording two-channel sound.
<b>Dialog Enhancer</b> [On] [Off] <input type="text"/> RAM L+R/R/L/R DVD-V DVD-A Dolby Digital, only with 3 or more channels, including a center channel. The volume is increased so that dialogs are easier to understand.	

DISPLAY  ▼▲ Other ▶ ▼▲ Option ▶ ▼▲ Setting

<b>Sound</b> Position 1	<b>Position</b> [1 - 5] Position of the OSD displays on the screen
----------------------------	---

# STATUS displays (Banner)

DVB only

Banners contain compact programme information on the current and next programme.

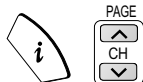

## Displaying the Banner

- Change stations (**CH ▲▼** or numeric buttons).
- Press **ENTER** or **Ⓢ**.

## Hiding the Banner

- Press **RETURN** or wait 5 seconds.



- Press **CH ▲▼**. The next or the previous channel are displayed. The banner information is updated and the tuner changes to the new channel. If you press **RETURN** to hide the banner information, the new channel is displayed.
- Press **▼▲**. The next or the previous channel are displayed. The banner information is updated. But the tuner does not change the channel. If you press **RETURN** to hide the banner information, the old channel is displayed.

Banner information			
<b>1 Name</b>	Programme position and name of the current station.	<b>Change Profile</b>	Press the <b>blue</b> key to change the Category.
<b>Signal Condition</b>	[No signal; bad Signal; No Service] Shows the signal quality of the current station. No indication means good signal.	<b>info Ⓢ</b>	Press Ⓢ to display detailed information on the current programme.
<b>Category</b>	Shows which Category is currently selected. [Free TV, Radio, Information, Profile 1, Profile 2, Profile 3, Profile 4, All Services]	<b>Encrypted</b>	Appears if you selected a station with an encrypted signal. You cannot view it because the unit is for viewing and recording free to view channels only.
<b>10:46</b>	The current time.	<b>Multi-Audio</b>	Appears if the current programme is broadcast in multi-channel sound.
<b>Title</b>	Title and airtime of the current programme.	<b>TXT</b>	Appears if the MHEG service is available.
<b>Now / Next</b>	<b>Now:</b> Switch to information on the current programme. <b>Next:</b> Switch to information on the next programme.	<b>Subtitle</b>	Appears if subtitles are available for the current programme.

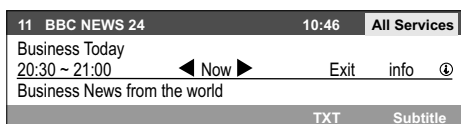

- If the Banner indicates that there is additional information available on the programme, press Ⓢ to display it.
- To exit the additional information, press Ⓢ again.

A Banner is also displayed for digital radio service and additional information can be displayed, if available.

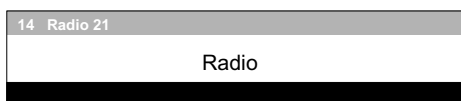

## Recording

DVB Banners cannot be recorded. Thus, you cannot display DVB Banners during a recording. One exception is a special recording Banner that appears during the recording of radio programmes. You cannot navigate in this Banner and it cannot be hidden. A similar Banner is displayed for "No Signal", "Bad Signal", "Encrypted programme", "No Service available" and "Channel unavailable".

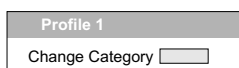

No Banners with information are displayed for analogue channels.

When changing channels or if you press the Ⓢ button, a Banner appears with the option of changing the current profile.

- Press the **blue** button to change the profile.
- The Banner disappears after 5 seconds.

# MHEG Service

DVB only

MHEG service is a digital teletext service provided by various broadcast organisations (not for analogue channels). Stations that offer the MHEG service can be identified by the [TXT] in the Banner.



- Press **TEXT** to launch the MHEG service. It may take some time for the information to load and display. Please be patient.
- Use **▼▲** to page up and down or use the numeric buttons to select a specific page number. The features depend on the respective station.
- The coloured buttons allow you to quickly access certain topic areas and the navigation to the MHEG pages. The features depend on the respective station.
- Press **TEXT** to exit the MHEG service.

Digital Teletext cannot be recorded. When subtitle is on or additional information in the banner is displayed, Digital Teletext does not work.

# STATUS displays

STATUS

## Displaying the information

- Press **STATUS**.
- Press **STATUS** again. The display changes each time that the button is pressed.
- To exit the display, press **STATUS**.

- 1: Current medium
- 2: Current recording and playback state

REC	Record		Pause playback
PAUSE	Pause recording	▶▶	Fast forward (5 speeds)
PLAY	Playback	◀◀	Rewind (5 speeds)
PLAYx1.3	Quick View (Playback x1.3)	▶▶ ◀◀	Slow motion Slow-motion rewind (5 speeds)

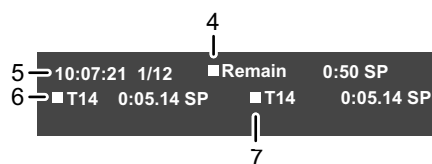
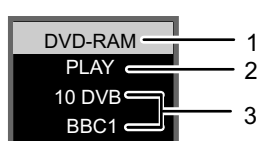

- 3: Current programme position and station name are displayed.  
DVB indicates that the station is digital.
- 4: Available recording time and recording mode: e.g. 0:50 SP shows 50 minutes in SP mode.
- 5: Current date and time
- 6: Title number: Also shows the recording mode and the current playback time of the title.
- 7: Title number: Also shows the recording mode and the current recording time of the title.  
*The status information changes depending on the function, e.g. PLAY, REC or REC PLAY.*

# Informations

This DVD Recorder is a precision unit. Handle it carefully and do not expose it to vibrations during recording. Otherwise there may be breaks or noises in the recordings.

The manufacturer accepts no responsibility and offers no compensation for loss of recorded or edited material nor for consequential damages attributed to a defect in the unit or the disc.

This product incorporates copyright protection technology that is protected by U.S. patents and other intellectual property rights. Use of this copyright protection technology must be authorized by Macrovision, and is intended for home and other limited viewing uses only unless otherwise authorized by Macrovision. Reverse engineering or disassembly is prohibited.

### DTS (Digital Theater Systems)

Sound system used in cinemas or movie theaters all over the world.  
DTS and DTS 2.0 + Digital Surround are trademarks of Digital Theater Systems, Inc.

### MHEG-5

(Multimedia and Hypermedia Expert Group) is an ISO Standard for interactive applications e.c. for digital TV. Typical examples of MHEG applications: electronic program guide, homeshopping and enhanced teletext service.

### Dolby Digital

Method of encoding digital signals. The signals are very much compressed in the process to enable recordings of large volumes of data. Manufactured under license from Dolby Laboratories. Dolby, Pro Logic and the double-D symbol are trademarks of Dolby Laboratories.

**MP3 or MPEG 1 Audio Layer 3** is a file compression format used for digital audio files. It provides files of an extremely small size and may cause a consequential loss of quality. MPEG Layer-3 audio decoding technology licensed from Fraunhofer IIS and Thomson multimedia.

## Before requesting service

<b>FUNCTION</b> No function possible.	▶ Check the power supply connection.
<b>The unit is switched on but cannot be used.</b>  <b>The error code «H□□», «U□□» or «F□□» appears:</b>	▶ There is a malfunction. The numbers following the letter «H» indicate the condition of the unit. • Switch the unit to standby $\mathcal{O}/I$ . If the unit does not switch to standby mode, press and hold $\mathcal{O}/I$ for approx. 10 seconds or unplug it from the power supply for approx. one minute and reconnect the cable. • Press $\mathcal{O}/I$ to switch the unit on. If the malfunction is not eliminated after this, contact customer service and provide the code that is displayed.
<b>The unit automatically switches to standby mode.</b>	▶ One of the unit's security devices may have been activated. Press $\mathcal{O}/I$ to switch the unit on.
<b>PICTURE</b> No picture.	▶ Check the connection to the television set, e.g. AV1. ▶ When Encrypted is shown, you cannot view because the unit is for viewing and recording free to view channels only. <span style="float: right;">10</span>
<b>Television reception worsens when the unit is connected.</b>	▶ Check the aerial connection. You may need to use a signal amplifier.
<b>The picture is not set correctly.</b>	▶ Check the [TV Aspect] setting in the Connection SETUP menu. <span style="float: right;">46</span>
<b>The picture flickers.</b>	▶ Adjust the picture. Read the operating instructions for the television.
<b>No on-screen messages.</b>	▶ Change the [On-Screen Messages] setting in the Display SETUP menu. <span style="float: right;">46</span>
<b>SOUND</b> No sound/ Volume set to quiet/ Distorted sound.	▶ Check the connections. ▶ If you have connected an amplifier, check its input mode. <span style="float: right;">53</span> ▶ Switch off the V.S.S. function if it causes problems.
<b>It is not possible to hear the desired sound type.</b>	▶ Press <b>DISPLAY</b> and select [audio channel], to change to the desired sound type. <span style="float: right;">88</span> ▶ Change the appropriate setting in the Sound SETUP menu.
<b>The sound cannot be set for stereo or NICAM broadcasts.</b>	▶ Connect external devices with audio cables even if you use a digital connection. <span style="float: right;">17</span> ▶ You cannot change the sound type when using DVD-R/-RW(V)/+R.
<b>DISPLAY</b> The display lighting is weak.	▶ Change the [FL Display] in the Display SETUP menu. <span style="float: right;">46</span>
<b>"0:00" blinks on the unit display.</b>	▶ No time. Set the time in the Others, [Clock] SETUP menu. <span style="float: right;">47</span>
<b>REMOTE CONTROL</b> No functions.	▶ If the unit is in TIMER standby mode ( $\oplus$ on the unit) end this with <b>TIMER</b> . ▶ A wrong remote control code was selected. ▶ Check the batteries. Point the remote control at sensor on the unit. ▶ The child lock feature has been activated. ▶ If the unit is in External Link Standby Mode (External Link is displayed on the unit) end this by pressing EXT LINK on the remote control.
<b>The television cannot be operated.</b>	▶ A wrong remote control code was selected. <span style="float: right;">7</span>

## Before requesting service

<b>PLAYBACK</b> Playback does not start.	<ul style="list-style-type: none"> <li>› The disc is dirty or badly scratched.</li> <li>› You inserted a disc that is not suitable for playback.</li> <li>› You inserted a blank disc.</li> </ul>
<b>Black screen is played.</b>	<ul style="list-style-type: none"> <li>› You may have recorded MHEG Data or encrypted programmes.</li> </ul>
<b>DVD-Video will not play.</b>	<ul style="list-style-type: none"> <li>› Some DVD-Videos cannot be played if the security level has been changed. <span style="float: right;">44</span></li> </ul>
<b>No reaction when the button is pressed.</b>	<ul style="list-style-type: none"> <li>›  appears on the screen. The procedure is stopped by the unit or the disc. <span style="float: right;">7</span></li> <li>› The child lock feature has been activated.</li> </ul>
<b>A title or chapter is not played back after being selected.</b>	<ul style="list-style-type: none"> <li>› Some titles and chapter of DVD-Video are not played back if the Ratings have changed. <span style="float: right;">44</span></li> </ul>
<b>Alternative soundtracks and subtitles cannot be selected.</b>	<ul style="list-style-type: none"> <li>› The languages were not recorded on the disc.</li> <li>› You may need to use the disc menu to select the languages.</li> </ul>
<b>The soundtrack/subtitle language does not match the language selected in the SETUP menu.</b>	<ul style="list-style-type: none"> <li>› The language is not recorded on the disc.</li> </ul>
<b>No subtitles.</b>	<ul style="list-style-type: none"> <li>› The subtitles are not recorded on the disc or are not switched on. <span style="float: right;">53</span></li> </ul>
<b>The perspective cannot be changed.</b>	<ul style="list-style-type: none"> <li>› The angle perspective can only be changed for scenes that were recorded in different angles.</li> </ul>
<b>You forgot your classification password.</b>	<ul style="list-style-type: none"> <li>› With the unit disc tray open, press and hold <b>REC</b> and <b>PLAY/ x1.3</b> simultaneously for at least 5 seconds.</li> </ul>
<b>EXTERNAL INPUT</b> Video or audio from external device is not recorded.	<ul style="list-style-type: none"> <li>› The external device is not connected correctly. <span style="float: right;">17</span></li> <li>› The correct external input channel AV2 or AV3 was not selected.</li> </ul>
<b>TV Guide</b> Is it possible to programme a recording, with a start and end time that are different from the TV Guide system?	<ul style="list-style-type: none"> <li>› You can manually change the start and end time of TIMER programmes in the TIMER RECORDING menu. <span style="float: right;">29</span></li> </ul>
<b>How can I cancel a TIMER programming?</b>	<ul style="list-style-type: none"> <li>› The "T" symbol appears in the TV Guide when a TIMER recording is programmed with the TV Guide system. To cancel a TIMER RECORDING programming, press <b>PROG/CHECK</b>. Select the desired entry and press <b>CANCEL</b>. <span style="float: right;">29</span></li> </ul>
<b>RECORDING</b> Cannot record.	<ul style="list-style-type: none"> <li>› Check whether the inserted disc is suitable for recording. <span style="float: right;">49</span></li> <li>› The disc is not formatted. Format the disc (RAM/DVD-RW). <span style="float: right;">20</span></li> <li>› The write-protection device on the Cartridge is set to "PROTECT". Deactivate the write protection. <span style="float: right;">49</span></li> <li>› If you activated the write protection, deactivate it in the DISC MANAGEMENT menu.</li> <li>› The material that you want to record is copy-protected. <span style="float: right;">49</span></li> </ul>
<b>Part or all recorded programmes were lost.</b>	<ul style="list-style-type: none"> <li>› If the power goes out during recording or editing or the power plug is disconnected from the power socket, the programme can be lost or the disc can be damaged.</li> </ul>
<b>TIMER-controlled recording is not working.</b>	<ul style="list-style-type: none"> <li>› The TIMER programming is incorrect or different TIMER-programmes are overlapping each other. Correct the programming. <span style="float: right;">29</span></li> <li>› The unit is in standby mode for TIMER-controlled recording. Press  <b>TIMER</b>.</li> <li>› Check the clock setting.</li> </ul>
<b>The TIMER-controlled recording cannot be cancelled.</b>	<ul style="list-style-type: none"> <li>› Press  <b>TIMER</b> during the TIMER-controlled recording. <span style="float: right;">32</span></li> <li>› In the case of a TIMER-controlled recording via an external device, press <b>EXT LINK</b>. EXT L disappears.</li> </ul>

# Specifications

<p><b>Recording System</b> DVD Video Recording format (DVD-RAM), DVD-Video format (DVD-R), DVD-Video format (DVD-RW)</p> <p><b>Recordable discs</b></p> <p><b>DVD-RAM :</b> Ver. 2.0 Ver. 2.1/3x--SPEED DVD-RAM Revision 1.0 Ver. 2.2/5x--SPEED DVD-RAM Revision 2.0</p> <p><b>DVD-R :</b> for General Ver. 2.0 for General Ver. 2.0/4x--SPEED DVD-R Revision 1.0 for General Ver. 2.x/8x--SPEED DVD-R Revision 3.0</p> <p><b>DVD-RW :</b> Ver. 1.1 Ver. 1.1/2x--SPEED DVD-RW Revision 1.0 Ver. 1.2/4x--SPEED DVD-RW Revision 2.0</p> <p><b>+R :</b> Ver. 1.0 Ver. 1.1 Ver. 1.2</p> <p><b>Recording Time</b> Maximum 8 hours (with 4.7 GB disc) XP: Approx. 1 hour SP: Approx. 2 hours LP: Approx. 4 hours EP: Approx. 6 hours/8 hours</p> <p><b>Playable discs</b> DVD-RAM, DVD-R, DVD-RW, +R, +RW, DVD-Video, DVD-Audio, CD-Audio (CD-DA), Video CD, CD-R/RW (MP3, CD-DA, Video CD, JPEG formatted discs), SVCD (conforming to IEC62107)</p> <p><b>Video</b> Video System: PAL colour signal, 625 lines, 50 fields NTSC colour signal, 525 lines, 60 fields Recording system: MPEG2 (Hybrid VBR) Video In (PAL/NTSC): AV1/AV2 (21 pin), AV3/AV4 (pin jack) 1 Vp-p 75 Ω, termination S-Video In (PAL/NTSC): AV2 (21 pin), AV3/AV4 (S terminal) 1 Vp-p 75 Ω, termination RGB In (PAL): AV2 (21 pin) 0.7 Vp-p (PAL) 75 Ω, termination</p>	<p>Video Out (PAL/NTSC): AV1/AV2 (21 pin), Video Out (pin jack) 1 Vp-p 75 Ω, termination S-Video Out (PAL/NTSC): AV1 (21 pin), S-Video Out (S terminal) 1 Vp-p 75 Ω, termination RGB Out (PAL/NTSC): AV1 (21 pin) 0.7 Vp-p (PAL) 75 Ω, termination Component video output (NTSC 480p/480i, PAL 576p/576i) Y: 1.0 Vp-p 75 Ω, termination P<sub>B</sub>: 0.7 Vp-p 75 Ω, termination P<sub>R</sub>: 0.7 Vp-p 75 Ω, termination</p> <p><b>Audio</b> Recording System: Dolby Digital 2ch Audio In: AV1/AV2 (21 pin), AV3/AV4 (pin jack) Input Level: Standard: 0.5 Vrms, Full scale: 2.0 Vrms at 1 kHz Input Impedance: More than 10 kΩ Audio Out: AV1/AV2 (21 pin), Audio Out (pin jack) Output Level: Standard: 0.5 Vrms, Full scale: 2.0 Vrms at 1 kHz Output Impedance: Less than 1 kΩ Digital Audio Out: Optical terminal (PCM, Dolby Digital, DTS, MPEG)</p> <p><b>Television System</b> Tuner System: DVB-T, PAL-I Channel Coverage: UHF: CH 21-68 RF Converter Output: UHF: CH 21-68 71±3 dBμV 75 Ω, termination</p> <p><b>LASER Specification</b> Class 1 LASER Product Wave Length: 795 nm (CDs), 662 nm (DVDs) Laser Performance: Class 3B/Class 3A (optical scan unit) No hazardous radiation is emitted with the safety protection</p> <p><b>Others</b> Region Code # 2 Operating Temperature: 5-40 °C Operating Humidity range: 10-80 % RH (no condensation) Power supply: AC 220-240 V, 50 Hz Power consumption: 28 W Dimensions (W×D×H): Approx. 430 mm × 350,5 mm × 63 mm Mass: Approx. 3.5 kg</p>
--	--

**Note:** The values given for weight and dimension are approximate values. The technical data can be changed without advanced notice.

# Index

	Page		Page		Page
Add New DVB Service	43	Grey Background	46	Satellite receiver	13,46
Audio channel	28,53	Interlace	8,16	Seamless play	45
Angle	53	Language codes	44	Shipping Condition	47
AV1 Output	46	MHEG	5,51,52	Signal Quality	43
AV2 Input	46	MP3	25,51	Slide Show	26,53
AV2 Settings	46	MPEG	45,51	Sound properties	53
Banner	52	Multi-Audio	5,53	Soundtrack	53
Bilingual Audio Selection	28,45	NTSC	21,34,55,46	Still Mode	45
Bitstream	45	On-Screen Messages	46	Subtitles	44,53
CD (MP3/JPEG)	25,26	Owner ID	11,14,47	System Update	47,48
Child lock	7	OPTICAL	8,17	Time	11,14,47
Comb Filter	45	PAL	21,46	TIME SLIP	24
CPRM / Cartridge-disc	20	PCM Down Conversion	45	Title Page	43
Date	11,14,47	PDC	28	TOP MENU	22,50
Default Settings	47	Playback NR	53	TV Aspect	46
Dialog Enhancer	53	Position	53	TV Guide	18,19
Digital Audio Output	17,45	Profiles	5,19,42	TV System	46
Disc formats	20,21	Progressive	8,16,46,53	V.S.S.	53
Disc Protection	49	Q-Link	11	Zoom	26
Dolby Digital	17,45,51	Quick Start	47		
DTS	17,45,51	Ratings	44		
DVD-Audio Video mode		Recording mode	28		
Playback	44	Recording time	28		
Dynamic Range Compression	45	Recording time in EP mode	44		
Ext Link	32,46	Repeat Play	53		
Finalize	50	RGB	16,46		
FL Display	46				
Folder	25,26				
Format Disc	49				